

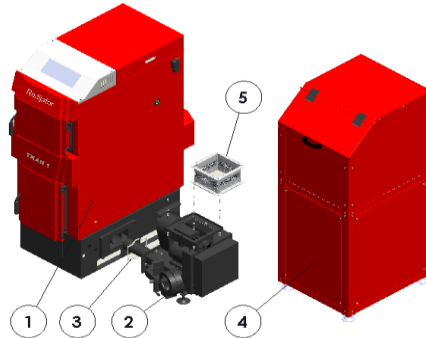

REZERVNI DELOVI TKAN 1 i 2

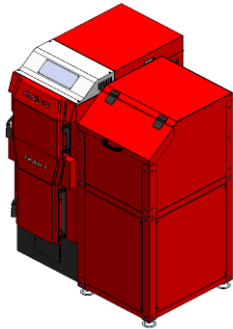







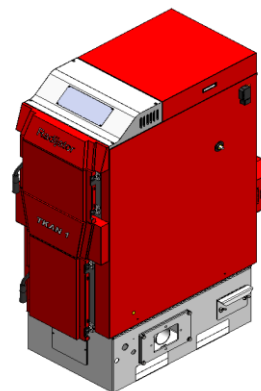
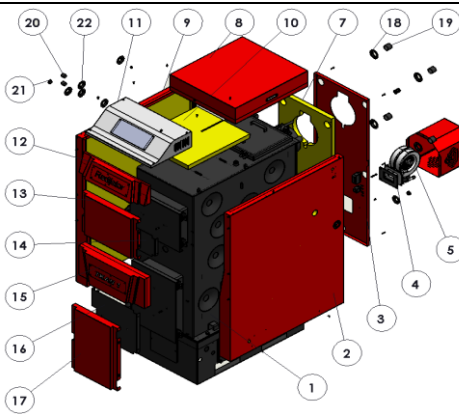















Spisak rezervnih delova za kotao TKAN 1 & TKAN 2 / List of spare parts for TKAN 1 & TKAN 2

No.	Slika dela / pictures of parts	NAZIV / NAME	Tip kotla / Type of boiler	Dimenzija / Dimesion	CODE PDM	CODE INFOerp	Q.	Težina / Weight (kg)
1		Kotao sa oplatom / Boiler of out side jacket	TKAN 1	520x1270x1560	S0002626		1	477
			TKAN 2	670x960x1670	S0002654		1	615
2		ČIŠĆENJE KOTLA (NORMA SAT) - Cena kotla sa OPLATOM	TKAN 1	520x1270x1560	S0002626		1	477
			TKAN 2	670x960x1670	S0002654		1	615
3		Rad na dozeru / Feeder	TKAN 1	560x732x540	SW-13927		1	58
			TKAN 2	560x800x550	SW-16004		1	61
4		Pletenica / Ceramic rope	TKAN 1	6x6 L=435	D0004582	00000029	1	
			TKAN 2				1	
5		Silos / Silo	TKAN 1	602x710x1565	S0002599		1	57
			TKAN 2				1	
6		Fleksibilna veza / Flexible connection	TKAN 1	243x243x132	S0003827		1	1,5
			TKAN 2				1	

KOTAO SA OPLATOM / Boiler of out side jacket TKAN 1 & TKAN 2



No.	Slika dela / pictures of parts	Naziv / Name	Tip kotla / Type of boiler	Dimenzija / Dimesion	CODE PDM	CODE INFOerp	Q.	Težina / Weight (kg)
1		Telo kotla sa ložištem / Body of boiler with socle of Combustion chamber	TKAN 1	520x1020x1480	S0002627		1	430
			TKAN 2	670x1200x1572	S0002655		1	560

2		Sklop bočne desne strane oplate / Right side hand panel	TKAN 1	900x1109x88	S0002777		1	9,5
			TKAN 2	965,5x1221x157	S0002792		1	11,8
3		Zadnja strana oplate / Back panel	TKAN 1	420x1109x20	SW-16477		1	3
			TKAN 2	570x1221x21	D0012261		1	4,8
4		Guma na pribirnici ventilatora / Seal for fan	TKAN 1	140x95x4	K0000853		1	0,036
			TKAN 2				1	
5		Ventilator, WPA120 (R2E120-AR38-40) / Fan	TKAN 1	160x210x180	K0001121	00008041	1	/
			TKAN 2				1	
6		Kutija za ventilator / Box of fan	TKAN 1	275x230x265	S0003298		1	1,7
			TKAN 2				1	
7		Izolacija zadnje strane oplate / Insolation of back panel	TKAN 1	417x1106x30	SW-16730		1	0,6
			TKAN 2	557x1217x30	SW-18543		1	0,9
8		Sklop krova oplate / Top panel	TKAN 1	520x576x120	S0002775		1	4,25
			TKAN 2	670x641x120	S0003310		1	5,6
9		Sklop bočne leve strane oplate / Left side hand panel	TKAN 1	900x1109x88	S0002776		1	9,5
			TKAN 2	966x1221x157	S0002798		1	11,8
10		Izolacija krova / Insolation of top panel	TKAN 1	420x490x30	D0014599		1	0,3
			TKAN 2	570x555x30	D0014700		1	0,5
11		Kučičke automatike / Control panel	TKAN 1	520x323x120	S0002591		1	3,2
			TKAN 2	670x323x120	S0002683		1	4
12		Prednja gornja strana oplate / Front-top panel	TKAN 1	520x134,5x84,5	S0002641		1	1,9
			TKAN 2	670x147,5x80,5	S0002685			2,2
13		Lim maske gornjih vrata oplate / Panel of upper door	TKAN 1	440x301x46	D0009014		1	1,2
			TKAN 2				1	
14		Nosач maske gornjih vrata / Carrier of panel for upper door	TKAN 1	438x160x23	D0022054		1	0,9
			TKAN 2				1	
15		Medjuvratnik oplate / Front middle panel part	TKAN 1	520x224,5x85	S0002642		1	2,8
			TKAN 2	670x324,5x82	S0002684		1	3,9
16		Nosач maske donjih vrata / Carrier of panel for lower door	TKAN 1	358x332x23	D0022745		1	1,5
			TKAN 2				1	
17		Lim maske donjih vrata oplate / Panel of upper door	TKAN 1	360x473	D0022752		1	1,5
			TKAN 2				1	
18		Ukrasna guma 1"	TKAN 1	/	K0000168		4	/
			TKAN 2		K0000232		4	
19		Plasticni ukrasni spoljni cep 1"	TKAN 1	/	K0000171		4	/
			TKAN 2		K0000230		4	
20		Plasticni ukrasni spoljni cep 1/2"	TKAN 1	/	K0000172		2	/
			TKAN 2				2	
21		Plasticni ukrasni unutrasnji cep 1/2"	TKAN 1	/	K0000174		3	/
			TKAN 2				3	
22		Ukrasna guma 3/4"	TKAN 1	/	K0000170		7	/
			TKAN 2				7	
23		Grejač 300 W / Ignitioner	TKAN 1	/	K0001193		1	/
			TKAN 2				1	

DOZER TKAN 1 & TKAN 2

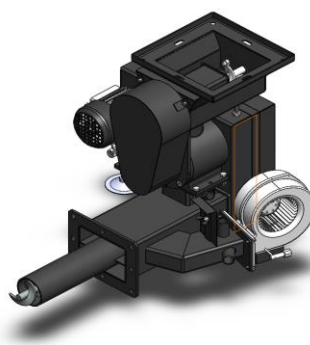
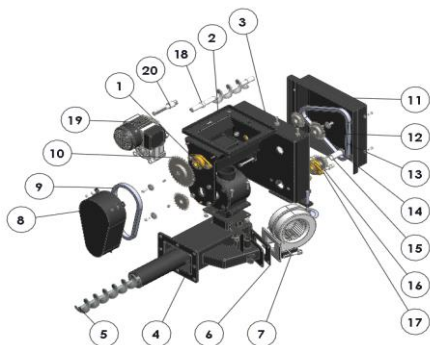







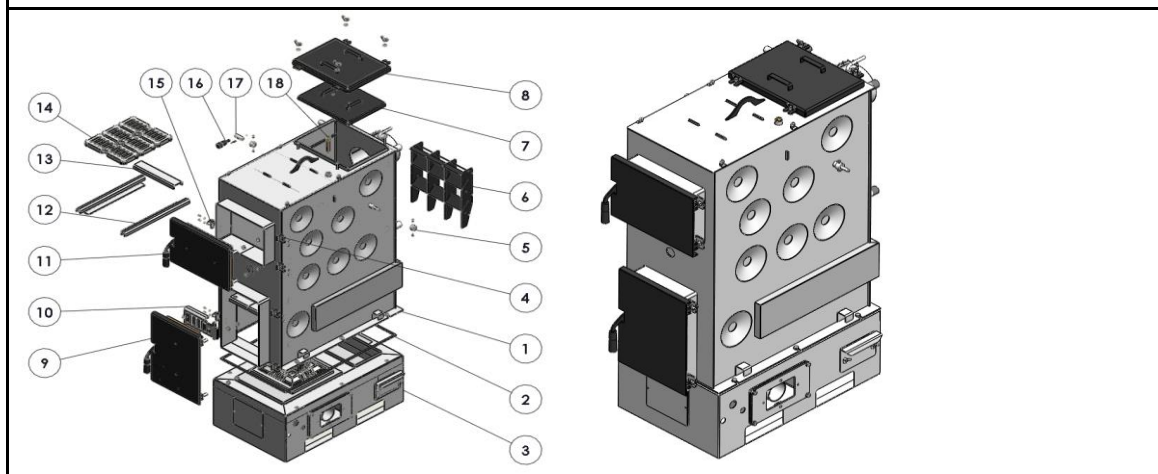











No.	Slika dela / pictures of parts	Naziv / Name	Tip kotla / Type of boiler	Dimenzija / Dimension	CODE PDM	CODE INFOerp	Q.	Težina / Weight (kg)
1		Valvola-čeljski transporter / Cell wheel	TKAN 1	210x172x155	SW-3808	00011540	1	9,2
			TKAN 2				1	
2		Gornji sklop dozera	TKAN 1	329x255x313	SW-3820		1	7,5
			TKAN 2	329x255x323	SW-2499		1	8,6
3		Kutija lančanika	TKAN 1	430x416x316	S0001557		1	9
			TKAN 2				1	
4		Donji sklop dozera	TKAN 1	545x337x208,5	SW-3930		1	10,6
			TKAN 2		SW-16015		1	
5		Donja spirala / Lowe feeder spiral	TKAN 1	L=712,5mm	SW-14016	00014042	1	2
			TKAN 2	L=776mm	SW-16042	00014043	1	2,9
6		Guma na pribrubnici ventilatora	TKAN 1	140x95	K0000853		1	/
			TKAN 2				1	
7		Ventilator, WPA120 (R2E120-AR38-40) / FAN	TKAN 1	210x180x158	K0001121	00008041	1	
			TKAN 2				1	
8		Poklopac lančanika / Cover chainwheel	TKAN 1	305x170x91	S0000682	00011592	1	0,7
			TKAN 2					
9		Prenosnik snage LANAC-kraći / Power transmission chain - shorter	TKAN 1	083 650	D0016699	00011506	1	
			TKAN 2					
10		Lančanik, 33Z 08B DIN 8192 / Chainwheel	TKAN 1	083 Z33	K0000090	00011534	1	
			TKAN 2					
11		Poklopac kutije lančanika / Cover chainwheel	TKAN 1	356x323x95	SW-4954	00011583	1	
			TKAN 2				1	
12		Lančanik, 18Z 08B DIN 8192 / Chainwheel	TKAN 1	083 Z18	K0000089	00011508	2	
			TKAN 2				2	
13		Prenosnik snage LANAC-duži / Power transmission chain - longer	TKAN 1	083 662	D0016700	00011506	1	
			TKAN 2				1	
14		Pritezna pločica lančanika	TKAN 1		SW-3833		6	0,02
			TKAN 2				6	
15		Čaura veće osovine drugog ležaja	TKAN 1	25x50	SW-4512		1	
			TKAN 2				1	
16		Lančanik, 15Z 08B DIN 8192 / Chainwheel	TKAN 1	083 Z15	K0000087	00011507	2	
			TKAN 2				2	
17		Ležaj-UCFL 204 - dm20 / Bearing UCFL 204	TKAN 1	UCFL 204	K0000096	00012290	4	
			TKAN 2				4	

18		Spirala gornja / Upper feeder spiral	TKAN 1	L=327,5mm	SW-3822		1	0,9
			TKAN 2		SW-2507		1	1,1
19		Motor - reduktor ABM 0.090kw	TKAN 1	145x210x182	K0000401		1	
			TKAN 2				1	
20		Osovina motora / Axle for motor	TKAN 1	L=118mm	D0005009		1	0,3
			TKAN 2				1	
21		Kućišta valvole-čelijski transporter / Housing Cell wheel	TKAN 1		SW-3802		1	
			TKAN 2				1	
22		Poklopac valvole / Cover cell wheel	TKAN 1		SW-3804		1	
			TKAN 2				1	
23		Čaura rotora veća	TKAN 1		SW-3806		1	
			TKAN 2				1	
24		Čaura rotora manja	TKAN 1		SW-3807		1	
			TKAN 2				1	
25		Ležaj 6004 2RS / Bearing 6004 2RS	TKAN 1	6004 2RS	K0000104	00008401	2	
			TKAN 2				2	
26		Rotor valvole	TKAN 1		SW-3803		1	
			TKAN 2				1	
27		Stopica dozera / Legs of feeder	TKAN 1	M12 x 120	K0000139	00014044	2	0,3
			TKAN 2				2	

SKLOP KOTLA I LOŽIŠTA / Assembly of Exchanger and Combustion chamber TKAN 1 & TKAN 2

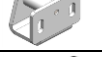

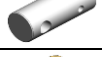





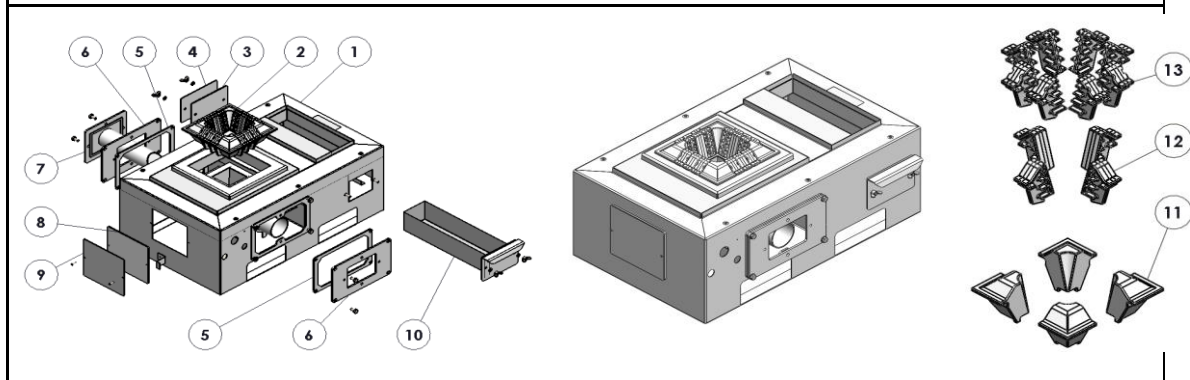





No.	Slika dela / pictures of parts	Naziv / Name	Tip kotla / Type of boiler	Dimenzija / Dimesion	CODE PDM	CODE INFOerp	Q.	Težina / Weight (kg)
1		Sklop izmenjivača / Exchanger	TKAN 1	520x1055x1147	S0002628		1	252
			TKAN 2	670x1120x1250	S0002656		1	342
2		Pletenica ložišta / Ceramic rope of Combustion chamber	TKAN 1	10x10x2490	D0005055		1	
			TKAN 2	10x10x3060	D0005512		1	
3		Ložište / Combustion chamber	TKAN 1	520x845x320	SW-15309	00014046	1	90
			TKAN 2	670x960x320	SW-13474	00014047	1	110
4		Sklop desne šarke	TKAN 1	50x40x27	S0004923		4	0,1
			TKAN 2				4	
5		Sklop zaptivnog dela klapne / Sealing of flap	TKAN 1	Ø30x20	SW-18534		2	
			TKAN 2				2	
6		Turbulator / Turbulator	TKAN 1	120x80x380	SW-14101	00014036	3	2,3
			TKAN 2	160x80x380	SW-14188	00014037	3	2,7

7		Unutrašnji poklopac proreza za čišćenje / Inside cover of cleaning	TKAN 1	274x363x55	SW-6167		1	5
			TKAN 2	484x275x65	SW-8468		1	6,7
8		Spoljašnji poklopac proreza za čišćenje / Outside cover of cleaning	TKAN 1	387x400x65	SW-4994		1	8,5
			TKAN 2	518x387x64	SW-8459		1	10,5
9		Donja vrata / Lower door	TKAN 1	350x462x115	S0003210	00000060	1	23
			TKAN 2				1	
10		Rešetka donjih vrata / Grid lower door	TKAN 1	237x115x50	SW-16853		1	1,3
			TKAN 2			1		
11		Livena gornja vrata / Upper door	TKAN 1	425x290x140	S0003258		1	20
			TKAN 2			1		
12		Noslač rosta / Carrier of roset	TKAN 1	60x465x36	SW-15243		2	2,3
			TKAN 2	110x531x36	SW-15342		2	3,6
13		U profil rostova	TKAN 1	290x64x25	SW-5846		1	1
			TKAN 2	/	/		1	
14		Rost	TKAN 1	290x120x25	K0000273		3	4,3
			TKAN 2			4		
15		Sklop šarke za završljivanje / Hinge	TKAN 1	36x45x34	S0004684		2	
			TKAN 2			2		
16		Plasticna rucica klapne / Plastic Handle flap	TKAN 1	30x95 (M10)	K0000142	00000176	1	
			TKAN 2				1	
17		Deo ručica klapne/ Part of handle flap	TKAN 1	Ø20x50	SW-3694		1	
			TKAN 2			1		
18		Sonda 1/2" x 110 mm	TKAN 1		K0000349		1	
			TKAN 2	1				

LOŽIŠTE / Combustion chamber TKAN 1 & TKAN 2









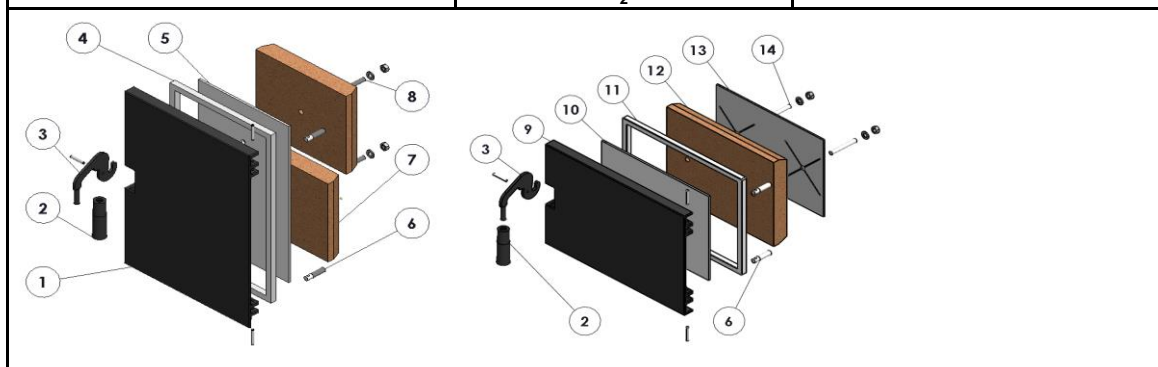

No.	Slika dela / pictures of parts	Naziv / Name	Tip kotla / Type of boiler	Dimenzija / Dimension	CODE PDM	CODE INFOerp	Q.	Težina / Weight (kg)
1	/	/	TKAN 1		/	/	1	/
			TKAN 2		/	/	1	/
2		Sklop livenih segmenata	TKAN 1	248x248	SW-7475	/	1	13,5
			TKAN 2	280x280	SW-9974			15,5
3		Izolacioni karton bočnog proreza	TKAN 1	120x185	SW-1827		1	0,1
			TKAN 2			1		
4		Poklopac bočnog proreza	TKAN 1	120x185	SW-1828		1	0,6
			TKAN 2			1		







5		Izolacija prirubnica ložišta / Insolation of flange of combustion chamber	TKAN 1	300x173	SW-4971		2	0,3
			TKAN 2				2	
6		Prirubnica ložišta / Flange of combustion chamber	TKAN 1	300x173	SW-4970		2	2,5
			TKAN 2	300x173	SW-15382		2	2,5
7		Poklopac ložišta / Combustion chamber cover	TKAN 1	210x160x265	SW-5012	00011602	1	3,5
			TKAN 2	210x160x352	SW-15425	00011602	1	4,5
8		Izolacija prednjeg poklopca ložišta / Insolation (#5) for front cover of combustion chamber	TKAN 1	210x180	SW-1755		1	0,2
			TKAN 2				1	
9		Poklopac prednjeg dela ložišta / Cover for front side of combustion chamber	TKAN 1	210x180	SW-1753	00014040	1	1
			TKAN 2				1	
10		Pepeljara ložišta / Ashtray	TKAN 1	185x120x480	SW-3011	00011612	1	1,7
			TKAN 2	185x120x636	SW-9952	00011609	1	2
11		Ugaoni liveni segment / Casting segment - corner	TKAN 1	76x76x95	K0000289		4	1,9
			TKAN 2				4	
12		Zatvoreni segment / Casting segment - closed	TKAN 1	76x105x32	K0000290		4	0,6
			TKAN 2				8	
13		Otvoreni segmentom / Casting segment - open	TKAN 1	76x105x32	K0000291		8	0,5
			TKAN 2				8	

DONJA VRATA / Lower door **TKAN 1 & TKAN 2**

GORNJA VRATA / Upper door **TKAN 1 & TKAN 2**



No.	Slika dela / pictures of parts	Naziv / Name	Tip kotla / Type of boiler	Dimenzija / Dimension	CODE PDM	CODE INFOerp	Q.	Težina / Weight (kg)
1		Livena donja vrata	TKAN 1	350x462	D0011803		1	11,5
			TKAN 2				1	
2		Plastična ručica / Plastic of handle for door	TKAN 1	30x100 (M12)	K0000155	00000175	2	0,2
			TKAN 2				2	
3		Sklop ručice / Handle for the door	TKAN 1	111x102 (M12)	S0003659		2	0,3
			TKAN 2				2	
4		Pletenica donjih vrata	TKAN 1	14x14x1480	D0011804	00000029	1	0,3
			TKAN 2				1	
5		Izolacioni karton	TKAN 1	252x419	D0008638		1	0,5
			TKAN 2				1	
6		Brezon šarke vrata / Bolt the hinge	TKAN 1	M12x50	SW-3713		4	0,1
			TKAN 2				4	
7		Vatrostalna opeka donjih vrata / Bricks for the lower door	TKAN 1	209x252x40	K0000254	00011866	2	5
			TKAN 2				2	

8		Navojna šipka M10	TKAN 1	M10x65	D0011805		2	0,1
			TKAN 2				2	
9		Livena gornja vrata	TKAN 1	425x290	D0011910		1	9
			TKAN 2				1	
10		Izolacioni karton gornjih vrata	TKAN 1	326x245	D0016803		1	/
			TKAN 2				1	
11		Pletenica gornjih livenih vrata / Ceramic rope	TKAN 1	14x14x1290	D0011912	00000029	1	/
			TKAN 2				1	
12		Vatrostalna opeka gornjih vrata / Bricks for the upper door	TKAN 1	245x360x40	K0000255	00011865	1	7,5
			TKAN 2				1	
13		Ploča izolacije gornjih vrata / Fireproof board of upper door	TKAN 1	224x326	SW-17318		1	2,5
			TKAN 2				1	
14		Navojna šipka M10	TKAN 1	M10 x 75	D0011911		1	/
			TKAN 2				1	

ELEKTRO KOMPANENETE i OSTALO / Electrical component & other TKAN 1 & TKAN 2

No.	Slika dela / pictures of parts	Naziv / Name	Tip kotla / Type of boiler	Dimenzija / Dimension	CODE PDM	CODE INFOerp	Q.	Težina / Weight (kg)
1		Automatika (TIEMMA) kompletna / Complete CONTROL (TIEMME) BEZ OŽIČENJA	TKAN 1	/	K0000408	00011792	1	
			TKAN 2				1	
2		Osigurač za automatiku / Fuse for control	TKAN 1		nema za sada	00011017	1	
			TKAN 2				1	
3		Sonda dimnovodnih gasova / Flue gas probe	TKAN 1	L=2500	K0001362	00014017	1	
			TKAN 2				1	
4		Sonda vode / Water probe	TKAN 1	L=2000	K0001478		1	
			TKAN 2				1	
5		2-polna keramička klema / 2-pole ceramic terminal	TKAN 1	/	K0001325	00012094	1	
			TKAN 2				1	
6		Fex.rebrasto crevo Ø8 / Flexible ribbed pipe Ø8	TKAN 1	5m	K0001084		1	
			TKAN 2	5,4m	K0001084		1	
7		Fex.rebrasto crevo Ø10 / Flexible ribbed pipe Ø10	TKAN 1	3,6m	K0001186		1	
			TKAN 2	3,9m	K0001186		1	
8		Fex.rebrasto crevo Ø12 / Flexible ribbed pipe Ø12	TKAN 1	1,3m	K0001086		1	
			TKAN 2	1,4m	K0001086		1	
9		Fex.rebrasto crevo Ø28 / Flexible ribbed pipe Ø28	TKAN 1	0,5m	K0001187		1	
			TKAN 2	0,55m	K0001187		1	
10		7-polni konektor muški / 7-pole connector atach	TKAN 1	/	K0000277	00008279	3	
			TKAN 2				3	
11		7-polni konektor ženski / 7-pole connector	TKAN 1		K0000540	00008268	2	
			TKAN 2				2	
12		3-polni konektor muški / 3-pole connector atach	TKAN 1		K0000278	00009448	1	
			TKAN 2				1	
13		3-polni konektor ženski / 3-pole connector	TKAN 1		K0001090	00009449	1	
			TKAN 2				1	
14		Uvodnik PG11 / Nylon cable gland PG11	TKAN 1		K0000414	00009488	1	
			TKAN 2				1	

15		Gumeni uvodnik / Rubber cable gland	TKAN 1			00013504	4	
			TKAN 2				4	
16		Silikonska žica (žuto zelena) / Silicone wire (yellow-green)	TKAN 1	7,3m	K0001076	00011908	1	
			TKAN 2	9,3m			1	
17		Silikonska žica (braon) / Silicone wire (brown)	TKAN 1	6,2m	K0001077		1	
			TKAN 2	6,7m			1	
18		Silikonska žica (crna) / Silicone wire (black)	TKAN 1	3,2m	K0001081		1	
			TKAN 2	3,4m			1	
19		Silikonska žica (žuto) / Silicone wire (yellow)	TKAN 1	1,1m	K0001080		1	
			TKAN 2				1	
20		Silikonska žica (crvena) / Silicone wire (red)	TKAN 1	6,4m	K0001079		1	
			TKAN 2	7m	K0001079		1	
21		Silikonska žica (bela) / Silicone wire (white)	TKAN 1	4,1m	K0001082		1	
			TKAN 2	4,5m	K0001082		1	
22		Silikonska žica (plava) / Silicone wire (blu)	TKAN 1	6,2m	K0001078		1	
			TKAN 2	6,8m	K0001078		1	
23		Monofazni utikač / Single phase plug	TKAN 1		K0001101	00008471	1	
			TKAN 2				1	
24		Kabl 3x0,75 / Cable 3x0,75	TKAN 1	4,6m	K0001308	00008157	1	
			TKAN 2				1	
25		Obujmica - manja / Bracket for plastic pipe - smaller	TKAN 1		K0001226	00011521	2	
			TKAN 2				2	
26		Obujmica - veća / Bracket for plastic pipe - bigger	TKAN 1	/	K0001225	00011522	1	
			TKAN 2				1	
27		Šarka za vrata silosa / Hinge for silo	TKAN 1		K0000279		2	
			TKAN 2				2	
28		Ručica silosa / Handle for silo	TKAN 1	L=145mm	K0000282		1	
			TKAN 2				1	
29		Stopica silosa / Legs of silo	TKAN 1	M10x110	K0001585		4	
			TKAN 2				4	
30		Vrata silosa / Door of silo	TKAN 1	292x606,5x89	D0008840		1	3,7
			TKAN 2				1	
31		Bočna maska silosa TKAN - BioMAX	TKAN 1	585,5x750x20	D0009072		1	3,2
			TKAN 2				1	
32		Sigurnosni termostat 110-6°, C 250V ~. STB 115408 / Safety thermostat 110-6°, C 250V ~., STB 115408	TKAN 1		K0001345		1	
			TKAN 2					