

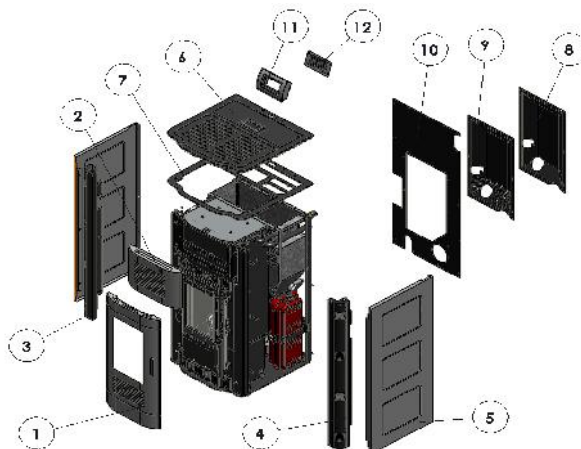

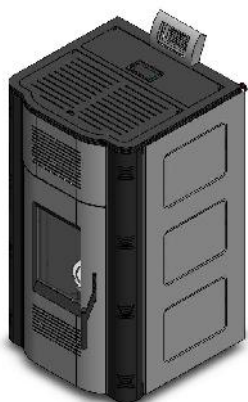



Kamin sa oplatom - BIOLUX 20









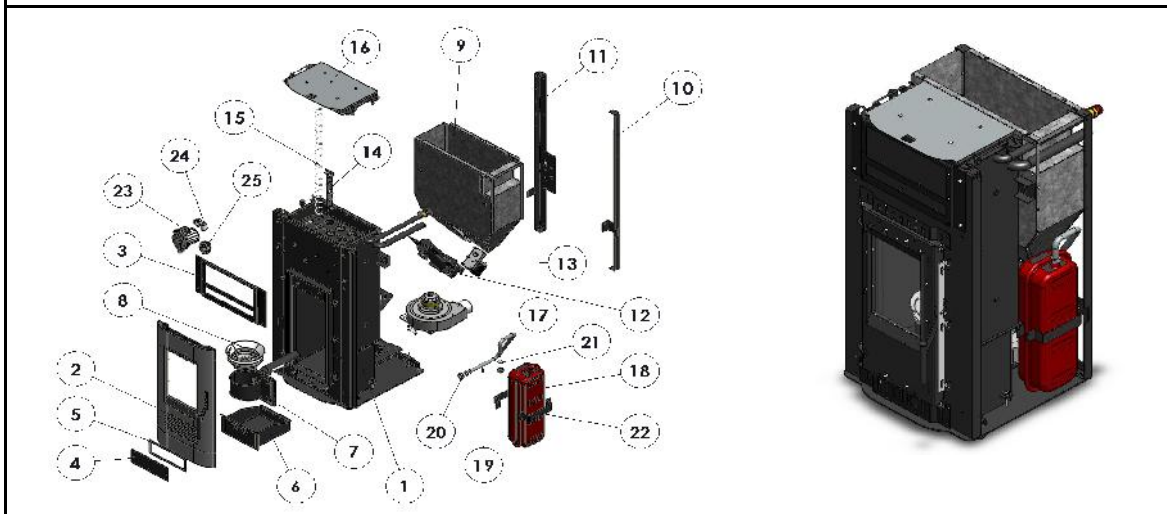

No.	Slika dela / pictures of parts	NAZIV / NAME	Tip kamina / Type of fireplace	Dimenzija / Dimension	CODE PDM	CODE INFOerp	Q.	Težina / Weight (kg)
0		IŠ ENJE KOTLA	BIOLux 20		S0004734			
1		Oplata vrata / Outside jacket door	BIOLux 20	402x53,1x799	S0003803		1	3.8
2		Prednja strana oplata/ Front panel	BIOLux 20	402x260x58,5	S0003824		1	1.40
3		Sklop bo ne desne lajsne oplata / Right side hand batten panel	BIOLux 20	1070x126x91	S0004419		1	2.63
4		Sklop bo ne leve lajsne oplata/ Left side hand batten panel	BIOLux 20	1070x126x91	S0004420		1	2.63
5		Bo na strana oplata/ Right/Left side panel of jacket	BIOLux 20	1067x480x37	S0004107		2	3.90
6		Sklop gornje plotne/ Assembly of top plate	BIOLux 20	600x600x32	S0003842		1	16.10
7		Osnovni lim plotne/ Basic part of plate	BIOLux 20	600x600x5	D0017025		1	4.40
8		Poklopac zadnje strane oplata/ Cover of back panel	BIOLux 20	597x357x51	D0017507		1	1.75
9		Poklopac zadnje strane oplata/ Cover of back panel	BIOLux 20	597x357x51	D0022942		1	1.36

10		Zadnja strana oplate / Back panel	BIOlux 20	1064x520x1,2	S0004418		1	3.30	
11		Ku ište displeja automatike / Control panel	BIOlux 20	200x50x140	S0003850		1	0.80	
12		Poklopac ku išta displeja automatike/ Cover of control panel	BIOlux 20	180x93x1,2	D0017505		1	0.13	

Sklop kamina i ložišta / *Assembly of Exchanger and Combustion chamber* **BIOlux 20**







No.	Slika dela / pictures of parts	NAZIV / NAME	Tip kamina / Type of fireplace	Dimenzija / Dimension	CODE PDM	CODE INFOerp	Q.	Težina / Weight (kg)	
1		Sklop izmenjiva a / Heat exchanger	BIOlux 20	571x567x1072	S0003719		1	105.00	
2		Sklop vrata / Door assembly	BIOlux 20	100x400x799	S0003767		1	12.20	
3		Nosa eone oplate/ Carrier of front panel	BIOlux 20	497x245x12,5	D0017013		1	0.90	
4		Poklopac otvora za iš enje/ Cover for cleaning	BIOlux 20	260x90x3	D0015150		1	0.55	
5		Izolacija poklopca za iš enje/ Insulation of cover for cleaning	BIOlux 20	10x3x700	D0015149		1	0.02	
6		Pepeljara/ Ashtray	BIOlux 20	258x255x130	S0003884		1	2.00	
7		Kutija za sagorevanje/ Box for combustion chamber	BIOlux 20	500x224x230	S0003722		1	7.90	
8		Šolja za sagorevanje/ Combustion chamber	BIOlux 20	Ø100x105	S0004411		1	2.50	

9		Silos / Silo	BIOlux 20	547x260x678	S0003989		1	7.00	
10		Desni nosa silosa/ Right carrier of silo	BIOlux 20	1070x36,5x86	D0017749		1	1.90	
11		Levi nosa silosa/ Left carrier of silo	BIOlux 20	1070x110x92	D0016062		1	2.30	
12		STARI Dozer (bez motora)/ Feeder	BIOlux 20	365x90x177	S0005002		1	4.50	
12a		Sklop NOVOG dozatora sa dva klizna lezaja / Feeder	BioLux 20	447x177x130	S0005073		1	7.83	
13		Motor dozatora/ Gear motor	BIOlux 20	161x70x119	K0001126		1	3.50	
14		Sklop turbulatora/ Assembly of turbulator	BIOlux 20	267x34x60	S0004692		9	0.07	
15		Turbulator ži ani/ Wired turbulator	BIOlux 20	Ø5,5x2168	D0017520		6	0.40	
16		Poklopac izmenjiva a/ Cover of exchanger	BIOlux 20	292x467x64	S0004061		1	9.40	
17		Ku ište ventilatora / Housing of fan	BIOlux 20	300x235x157	S0004661		1	6.20	
18		Ekspanziona posuda 10L / Expansion vessels	BIOlux 20	530x200x120	K0000484		1	6.30	
19		Fleksibilno crevo ekspanziona posude/ Flexible pipe of expansion vessels	BIOlux 20	Ø20x609	D0017511		1	0.15	
20		Holender za inox crevo / Straight connector for the pipe of stainless steel	BIOlux 20	3/4"	K0001451		2	/	
21		Dihitung za holender 3/4" za inox crevo/ Metal gasket for the pipe of stainless steel	BIOlux 20	23,5x2	K0001450		2	/	
22		Lim šelne/ Panel of spring clamps	BIOlux 20	230x48x40	D0016992		2	0.30	
23		Pumpa/ Pump	BIOlux 20	RS25/6-3P,230V	K0000582		1	6.30	
24		Koleno / Elbow pipe	BIOlux 20	1"	K0000681		2	0.50	

25		Holender/ Straight connector	BIOlux 20	1"	K0001005		2	0.05	
----	---	-------------------------------------	-----------	----	----------	--	---	------	--

Sklop gornje plotne / Assembly of plate **BIOlux 20**



No.	Slika dela / pictures of parts	NAZIV / NAME	Tip kamina / Type of fireplace	Dimenzija / Dimesion	CODE PDM	CODE INFOerp	Q.	Težina / Weight (kg)
1		Sklop srednjeg dela plotne/ Assembly of middle part plate	BIOlux 20	600x600x5	S0003846		1	3.50
2		Sklop gornjeg dela plotne/ Assembly of top part plate	BIOlux 20	600x600x5	S0003848		1	3.50
3		Sklop vrata na plotni/ Assembly of door on plate	BIOlux 20	322x524x31,5	S0003845		1	5.60
4		Vrata silosa na plotni/ The door of silo on plate	BIOlux 20	170x524x5	D0017052		1	3.20
5		Sklop nabadaju e ru ice/ Handle for the door	BIOlux 20	164,4x93,1x28	K0000680		1	0.20

SKLOP VRATA / Assembly of door **BIOlux 20**

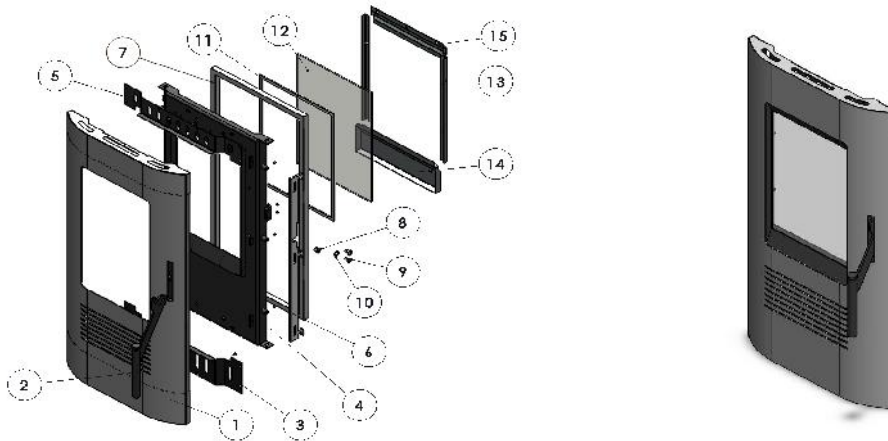





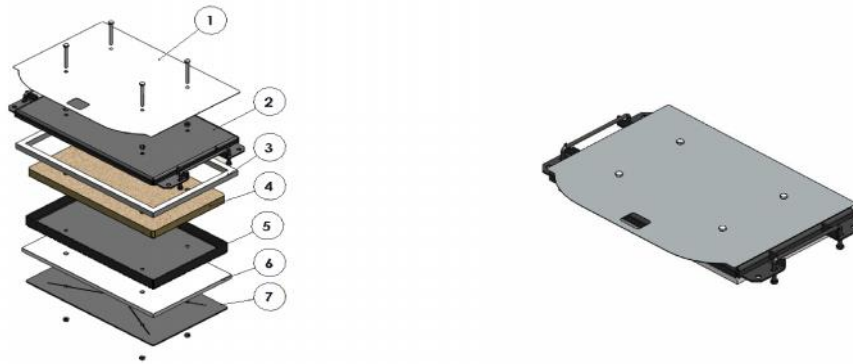

No.	Slika dela / pictures of parts	NAZIV / NAME	Tip kamina / Type of fireplace	Dimenzija / Dimesion	CODE PDM	CODE INFOerp	Q.	Težina / Weight (kg)
1		Oplata vrata / Door panel	BIOlux 20	402x53,1x799	S0003803		1	3.8

2		Sklop ručice vrata/ Handle for the door	BIOlux 20	285x120x20	S0003788		1	0.3	
3		Donji lim oplata vrata/ Lower panel of door	BIOlux 20	396x31x98	D0017479		1	0.4	
4		Vrata kamina/ The door of fireplace	BIOlux 20	366x60x656	S0003782		1	5.2	
5		Gornji lim oplata vrata/ Upper panel of door	BIOlux 20	396x31x66	D0017480		1	0.27	
6		Flah za završavanje vrata/ Door closing profile	BIOlux 20	520x41,5x5	D0016200		1	0.5	
7		Pletenica vrata/ Ceramic rope	BIOlux 20	14x14x1868	D0016989		1	0.3	
8		Ležaj/ Bearing	BIOlux 20	HK0810 DIN 618	K0001239		1	/	
9		Nosač ručice/ Carrier of handle	BIOlux 20	D8	K0001236		2	/	
10		Podloška zakrivljena/ Shim	BIOlux 20	D8 DIN 137 tip A	K0001238		1	/	
11		Pletenica za staklo/ Ceramic rope for glass	BIOlux 20	10x3x1126	D0016801		1	0.03	
12		Vatrootalno staklo kamina/ Refractory glass	BIOlux 20	250x350x4	K0000383		1	0.87	
13		Vinkla za stezanje stakla (bočna)/ The side profile for straining glass	BIOlux 20	335x11x17,4	D0016181		2	0.07	
14		Vinkla za zatezanje stakla (donja)/ The lower profile for straining glass	BIOlux 20	270x18,8x89,1	D0017506		1	0.2	
15		Usmerivač sekundara na vratima/ Router for secondary air on the door	BIOlux 20	243x12,8x55,2	D0019566		1	0.1	

Poklopac izmenjiva a BIOLux 20



No.	Slika dela / pictures of parts	NAZIV / NAME	Tip kamina / Type of fireplace	Dimenzija / Dimesion	CODE PDM	CODE INFOerp	Q.	Težina / Weight (kg)
1		Zaštitni lim poklopca izmenjiva a/ Protective of cover exchanger	BIOLux 20	400x297x0,8	D0020548		1	0.72
2		Sklop osnovnog lima poklopca izmenjiva a/ Assembly of basic cover exchanger	BIOLux 20	467x250x47	S0004096		1	3.1
3		Pletenica na donjem delu izmenjiva a/ Ceramic rope	BIOLux 20	14x14x1226	D0017673		1	0.2
4		Vermikulit poklopca izmenjiva a/ Insulation of cover exchanger	BIOLux 20	363x210x25	D0017744		1	0.95
5		Korito vermikulita/ Trough for insulation	BIOLux 20	369x216x28	D0017674		1	1.7
6		Izolacija poklopca izmenjiva a/ Insulation of cover exchanger	BIOLux 20	379x226x10	D0020360		1	0.82
7		Lim poklopca izmenjiva a/ Panel of cover exchanger	BIOLux 20	3x369x216	D0020358		1	1.86

STARI Dozer BIOLUX 20

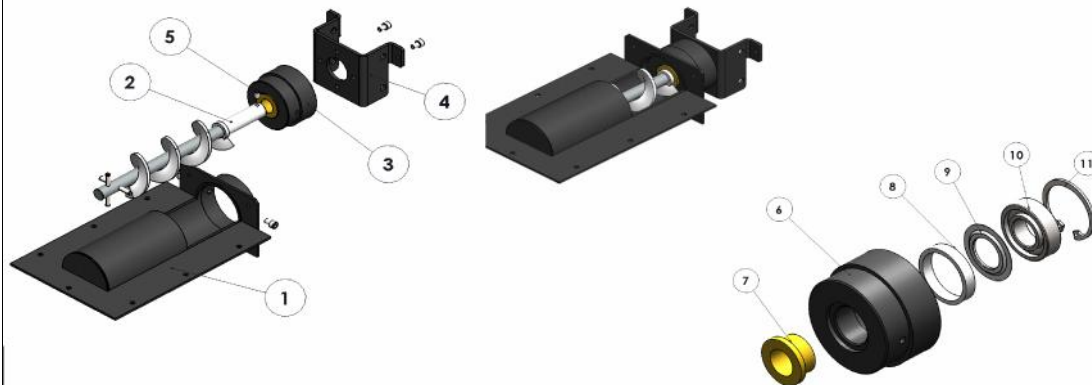

No.	Slika dela / pictures of parts	NAZIV / NAME	Tip kamina / Type of fireplace	Dimenzija / Dimension	CODE PDM	CODE INFOerp	Q.	Težina / Weight (kg)
1		Osnovni deo dozera/ Basic part of feeder	BIOLUX 20	290x177x90	S0004075		1	2.2
2		Spirala dozera/ Feeder spiral	BIOLUX 20	274x55	S0005003		1	0.7
3		Ku ište sa ležajevima dozatora/ Housing with bearings	BIOLUX 20	Ø76,1x46	S0005004		1	1.2
4		Nosa motora dozera/ Carrier of engine on feeder	BIOLUX 20	126x50x80	D0017602		1	0.41
5		Vijak bez glave sa imbus prihvatom/ Screw	BIOLUX 20	M6 x 10 DIN 914	K0000648		1	/
6		Ku ište ležaja dozatora/ Housing for bearing feeder	BIOLUX 20	Ø80x48	D0022082		1	1.2
7		Bronzana aura/ Bronze bushing	BIOLUX 20	Ø35x16	K0001021		1	0.05
8		aura distancera ležaja/ Spacer sleeve bearing	BIOLUX 20	Ø41,8x8	D0022084		1	0.023
9		Metalna zaptivka za ležaj/ Mild steel for bearing	BIOLUX 20	Ø41,9x0,8	K0001412		1	0.03
10		Ležaj/ Bearing	BIOLUX 20	6004 DIN 625	K0000104		1	0.01
11		Zeger/ Sicherung	BIOLUX 20	42 x 1.72	K0000683		1	/

NOVI Dozer - BIOlux 20

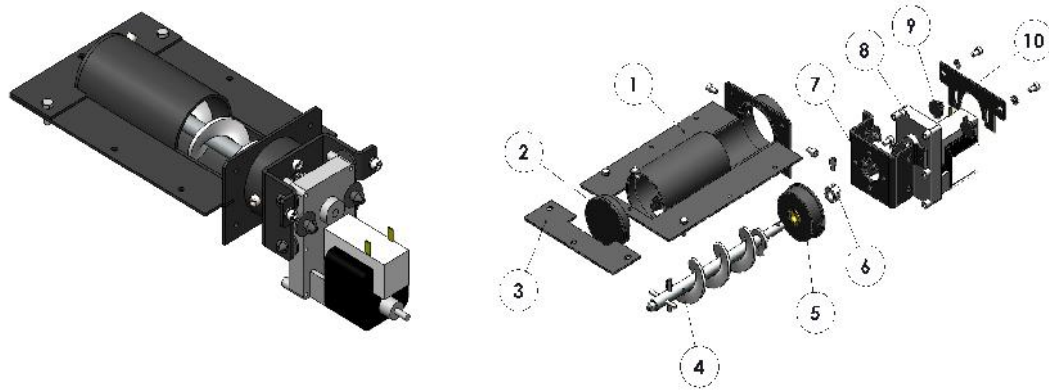

No.	Slika dela / Pictures of parts	NAZIV / NAME	Tip kotla / Type of boiler	Dimenzija / Dimension (mm)	CODE PDM	CODE INFOerp	Q.	Težina / Weight (kg)
1		Osnovni deo dozera BIOlux 20 - sa 2 klizna ležaja / Basic part of feeder	BioLux - Uni 20	289x177x100	S0005074		1	2.7
2		Sklop upresovane aure gornjeg poklopca dozera BIOlux 20	BioLux - Uni 20	Ø76.1x19	S0006061		1	0.5
3		Plo ica dozera kod gornjeg poklopca	BioLux - Uni 20	177x55x3	D0022654		1	0.19
4		Spirala dozera BIOlux 20 sa 2 klizna ležaja / Feeder spiral	BioLux - Uni 20	Ø52x264	S0005075		1	0.6
5		Sklop donjeg poklopca dozera	BioLux - Uni 20	Ø76.1x25	S0005080		1	0.58
6		aure za vezivanje motora dozatora BIOlux 20	BioLux - Uni 20	Ø22x12	D0032428		1	0.024
7		Nosa motora dozera / Carrier of engine on feeder	BioLux - Uni 20	126x80x50	D0017602		1	0.4
8		Motor dozatora-PELET KAMIN / Motor on feeder	BioLux - Uni 20	119x135x70	K0001126		1	3.42
9		Vibracioni ep 8	BioLux - Uni 20	/	K0001747		6	/
10		Nosa motora dozera (KENTA) BIOlux 20 / Carrier of engine on feeder	BioLux - Uni 20	130x58x2	D0030534		1	0.07

ELEKTRO KOMPONENTE i OSTALO / Electrical component & other BIOlux 20

No.	Slika dela / pictures of parts	Naziv / Name	Tip kotla / Type of boiler	Dimenzija / Dimension	CODE PDM	CODE INFOerp	Q.	Težina / Weight (kg)
1		Tropolni konektor, ženski, 250V 16A, EP 1110 S (EP3F+EP3gS) / 3-pole connector	BIOlux 20	/	K0001099	9449	4	/
2		Tropolni konektor, muški, 250V 16A, EP 1100 S (EP3M+EP3GS) / 3-pole connector attach	BIOlux 20	/	K0000278	9448	4	/

3		Fleksibilno crevo sa spiralom. Texoflex ECGFE08N. Pre nik Ø=8mm, Boja: crna. EN 61386-1, EN 61386-23 / Flexible ribbed pipe Ø=8mm	BIOlux 20	5 m	K0001084	12755	/	/	
4		Fleksibilno crevo sa spiralom. Texoflex ECGFE10N. Pre nik Ø=10mm, Boja: crna. EN 61386-1, EN 61386-23 / Flexible ribbed pipe Ø=10mm	BIOlux 20	6 m	K0001186	12754	/	/	
5		Automatika PSYSL01000149 / Control	BIOlux 20	1789x129x70	K0001164		1	1.00	
6		Sigurnosni termostat 110-6°C, 250V, STB 115408 / Safety thermostat	BIOlux 20	/	K0001345		1	0.43	
7		Presostat za vodu / Presostat	BIOlux 20	Ø84x50	K0001280		1	1.00	
8		Elektro greja FKK PSx - 6 - 240 - B / Ignitioner	BIOlux 20	/	K0001493		1	0.08	
9		Ventilator Ebmpapst R2E 180 - CG82 - 01 / Fan	BIOlux 20	Ø212x150	K0001494		1	4.30	
10		Automatika TIEMME SY 250 / Control TIEMME SY 250	BIOlux 20	/	K0001181		1	/	
12		Presostat vazduha PELET kamina / Pressure air switch PELLET stove	BIOlux 20	Ø84x50	K0001279		1	1.00	
13		Sonda dimovodnih gasova PELET kamina / Flue gas probe for PELLET stove	BIOlux 20	/	K0001477		1	/	
14		Sonda za vodu PELET kamina / Water probe for PELLET stove	BIOlux 20	/	K0001478		1	/	
15		Odzračni ventil od 1/2" PELET kamina / Relief valve 1/2" for PELLET stove	BIOlux 20	/	K0000559		2	/	

U Kraljevu 10.03.2016
M.P.

ODOBRIO:
Direktor Milan Jani