



Radijator

INŽENJERING





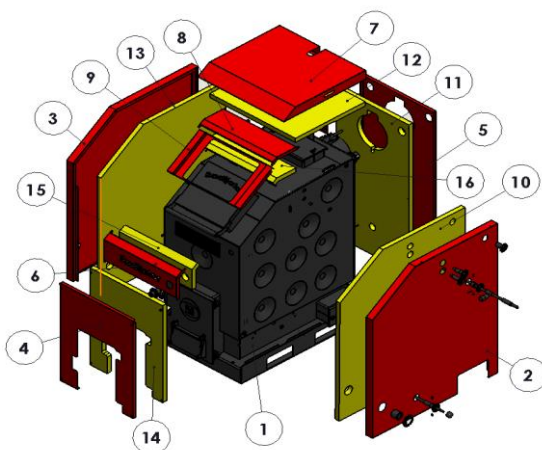













Spisak rezervnih delova za kotlove / List with spare parts for boilers K18.1; K25.1; K33.1; K40.1; K50; K65; K80



KOTAO SA OPLATOM / BOILER WITH SHELL K 40.1







No.	Naziv / Name	Slika dela / pictures of parts	Tip kotla / Type of boiler	Dimenzija / Dimension	CODE PDM	CODE INFOerp	Q.	Težina / Weight (kg)
1	Telo kotla/ Body for boiler		K 18.1	480x920x1040	S0002961		1	200,00
			K 25.1	530x1060x1130	S0002945		1	266,00
			K 33.1	580x1120x1180	S0002953		1	316,00
			K 40.1	670x1150x1260	S0002974		1	392,00
			K 50	770x1130x1290	SW - 6400		1	424,00
			K 65	870x1140x1640	SW-10934		1	485,00
			K 80	920x1200x1340	SW-10763		1	523,00
2	Lim bočne desne strane oplate/ Right hand side shell plate		K 18.1	70x790x892	D0010322		1	5,10
			K 25.1	70x885x990	D0009898		1	6,35
			K 33.1	70x955x1043	D0010079		1	7,20
			K 40.1	70x960x1093	D0010089		1	7,60
			K 50	50x960x1153	SW-10836		1	7,46
			K 65	50x960x1197	SW-10921		1	7,83
			K 80	50x988x1195	SW-10761		1	8,21
3	Lim bočne leve strane oplate/ Left hand side shell plate		K 18.1	70x790x892	D0010323		1	5,10
			K 25.1	70x885x990	D0009899		1	6,35
			K 33.1	70x955x1043	D0010080		1	7,20
			K 40.1	70x960x1093	D0010090		1	7,60
			K 50	50x960x1153	SW-10837		1	7,49
			K 65	50x960x1197	SW-10925		1	7,85
			K 80	50x988x1195	SW-10762		1	8,24
	U profil levi / desni/ U section left/right		K 18.1	19x31x450	D0011630/ D0011629		1	0,16

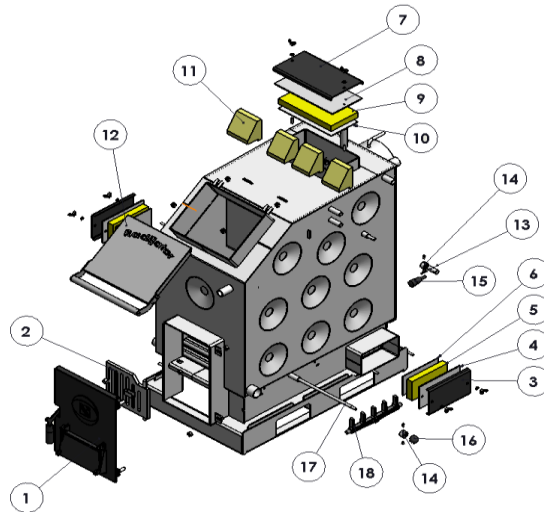

4	Lim prednje strane oplate/ Front shell plate		K 25.1	20x420x610	D0012077		1	0,93
			K 33.1	20x470x663	D0012152		1	1,30
			K 40.1	20x560x713	D0012259		1	1,90
			K 50	27x660x770	SW-10838		1	2,45
			K 65	27x758x815	SW-10926		1	3,18
			K 80	20x810x817	SW-10770		1	3,37
5	Lim zadnje strane oplate/ Back side shell plate		K 18.1	20x372x892	D0010328		1	2,20
			K 25.1	20x420x990	D0009903		1	2,67
			K 33.1	20x470x1043	D0010084		1	3,11
			K 40.1	20x560x1093	D0010381		1	3,90
			K 50	27x724x1136	SW-10839		1	5,30
			K 65	27x829x1181	SW-10927		1	6,24
6	Lim donje kosine oplate/ Lower slope shell plate		K 18.1	20x372x250	D0011628		1	1,50
			K 25.1	60x200x420	D0009901		1	1,15
			K 33.1	66x207x470	D0010082		1	1,35
	Kosina oplate/ Shell slope		K 40.1	66x207x560	D0010093		1	1,56
			K 50	130x535x660	SW-10842		1	1,98
			K 65	135x526x760	SW-10929		1	2,38
7	Krov oplate/ Top shell plate		K 80	135x526x810	SW-10771		1	2,56
			K 18.1	65x472x455	D0010340		1	2,00
			K 25.1	65x520x550	D0009897		1	2,66
			K 33.1	65x570x624	D0010085		1	3,20
			K 40.1	65x630x660	D0010379		1	3,64
			K 50	21x580x660	SW-10840		1	2,11
8	Lim gornje kosine oplate/ Upper slope shell plate		K 65	20x580x760	SW-10928		1	2,50
			K 80	20x629x810	SW-10769		1	3,01
			K 18.1	45x150x372	D0010324		1	0,40
	/	/	K 25.1	50x207x420	D0009900		1	0,66
			K 33.1	45x207x470	D0010081		1	0,70
			K 40.1	44x211x560	D0010091		1	0,84
9	Unutrašnji deo oplate/ Inside part of shell plate		K 50	/	/		/	/
			K 65	/	/		/	/
			K 80	/	/		/	/
			K 18.1	20x310x372	D0010327		1	0,40
			K 25.1	20x310x420	D0009902		1	0,40
			K 33.1	20x310x470	D0010083		1	0,42
10	Izolacija bočne desne strane oplate / Insulation for right hand side shell plate		K 40.1	20x308x560	D0010372		1	0,67
			K 50	/	/		/	/
			K 65	/	/		/	/
			K 80	/	/		/	/
			K 18.1	30x786x888	D0010373		1	0,93
			K 25.1	30x883x988	D0010198		1	1,20
11	Izolacija zadnje strane oplate / Insulation for back side shell plate		K 33.1	30x951x1040	D0011900		1	1,36
			K 40.1	30x956x1089	D0011957		1	1,44
			K 50	30x936x1150	SW-10886		1	1,50
			K 65	30x936x1193	SW-11109		1	1,56
			K 80	30x986x1193	SW-10830		1	1,64
			K 18.1	30x368x888	D0010375		1	0,43
12	Izolacija krova oplate / Insulation for top shell plate		K 25.1	30x416x985	D0012059		1	0,55
			K 33.1	30x466x1040	D0011907		1	0,65
			K 40.1	30x556x1089	D0011962		1	0,83
			K 50	30x720x1132	SW-10889		1	1,15
			K 65	30x825x1177	SW-11111		1	1,30
			K 80	30x877x1179	SW-10831		1	1,44
13	Izolacija bočne leve strane oplate / Insulation for left hand side shell plate		K 18.1	30x365x468	D0010378		1	0,25
			K 25.1	30x460x516	D0011882		1	0,35
			K 33.1	30x530x566	D0011905		1	0,44
			K 40.1	30x656x535	D0011961		1	0,52
			K 50	30x555x656	SW-10890		1	0,41
			K 65	30x556x756	SW-11113		1	0,50
14	Izolacija prednje strane oplate / Insulation for front shell plate		K 80	30x606x806	SW-10834		1	0,60
			K 18.1	30x786x888	D0010374		1	0,93
			K 25.1	30x883x988	D0010199		1	1,20
			K 33.1	30x951x1040	D0011901		1	1,36
			K 40.1	30x956x1089	D0011958		1	1,45
			K 50	30x936x1150	SW-10887		1	1,49
14	Izolacija prednje strane oplate / Insulation for front shell plate		K 65	30x936x1193	SW-11110		1	1,60
			K 80	30x986x1193	D0002091		1	1,65
			K 18.1	/	/		/	/
			K 25.1	30x606x416	SW-18557		1	0,16
			K 33.1	30x466x660	SW-18617		1	0,21
			K 40.1	30x556x710	SW-21168		1	0,38
14	Izolacija prednje strane oplate / Insulation for front shell plate		K 50	30x656x770	SW-10888		1	0,50
			K 65	30x756x813	SW-11112		1	0,65
			K 80	30x806x813	SW-10832		1	0,71





15	Izolacija prednje donje kosine oplate / Insulation for front lower slope shell plate		K 18.1	30x365x242	D0010376		1	0,14
			K 25.1	30x172x417	D0010201		1	0,10
			K 33.1	30x176x466	D0011902		1	0,12
			K 40.1	30x177x557	D0011959		1	0,15
15	Izolacija kosine oplate / Insulation for slope shell plate		K 50	30x530x660	SW-10891		1	0,37
			K 65	30x525x758	SW-11114		1	0,50
			K 80	30x534x806	SW-10833		1	0,49
16	Izolacija gornje kosine oplate / Insulation for upper slope shell plate		K 18.1	30x110x365	D0010377		1	0,06
			K 25.1	30x184x418	D0010200		1	0,11
			K 33.1	30x176x466	D0011903		1	0,12
			K 40.1	30x177x558	D0011960		1	0,14
			K 50	/	/		/	/
			K 65	/	/		/	/
			K 80	/	/		/	/

SKLOP KOTLA / BOILER ASSEMBLY K18.1; K25.1; K33.1; K40.1; K50; K65 ;K80







No.	Naziv / Name	Slika dela / pictures of parts	Tip kotla / Type of boiler	Dimenzija / Dimension	CODE PDM	CODE INFOerp	Q.	Težina / Weight (kg)
1	Livena donja vrata/ Cast lower door		K 18.1	78x352x460	SW-4333		1	15,96
			K 25.1					
			K 33.1					
			K 40.1					
1	Donja vrata / Lower door		K 50	67x504x397	SW-6403		1	18,10
			K 65					
			K 80					
2	Mala rešetka/ Small grid		K 18.1	34x215x240	K0000143		1	3,90
			K 25.1					
			K 33.1					
			K 40.1					
1	Velika rešetka / Big grid		K 50	14x250x293	K0000237		1	6,13
			K 65					
			K 80					
			K 80					
3	Poklopac otvora za čišćenje (bočni) / Cover for cleaning opening (on the side)		K 18.1	18x238x155	SW-4240		1	1,18
			K 25.1					
			K 33.1					
			K 40.1					
			K 50					
			K 65					
K 80								
4	Izolacija bočnih otvora za čišćenje / Insulation for side cleaning openings		K 18.1	5x120x238	SW-4292		1	0,14
			K 25.1					
			K 33.1					
			K 40.1					
			K 50					
			K 65					
			K 80					



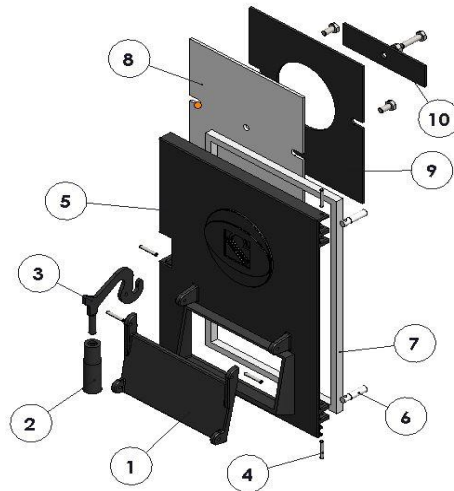



5	Tervol poklopca za čišćenje (manji) / Tervol for cleaning opening cover (smaller)		K 18.1	30x105x205	SW-4312		1	0,03
			K 25.1					
			K 33.1					
			K 40.1					
			K 50					
			K 65					
K 80								
6	Unutrašnji poklopac za čišćenje / Inner cover for cleaning opening		K 18.1	3x105x205	SW-4313		1	0,53
			K 25.1					
			K 33.1					
			K 40.1					
			K 50					
			K 65					
K 80								
7	Poklopac gornjeg otvora za čišćenje / Cover for upper cleaning opening		K 18.1	18x238x155	SW-4240		1	1,18
			K 25.1	18x186x336	SW-3741		1	2,21
			K 33.1					
			K 40.1	18x436x205	SW-6613		1	2,87
			K 50					
			K 65					
K 80								
8	Izolacija gornjeg otvora za čišćenje / Insulation for upper cleaning opening		K 18.1	5x120x238	SW-4292		1	0,14
			K 25.1	5x172x336	SW-3743		1	0,27
			K 33.1					
			K 40.1	5x172x436	SW-6614		1	0,35
			K 50					
			K 65					
K 80								
9	Tervol gornjeg poklopca za čišćenje / Tervol for upper cleaning cover		K 18.1	30x105x205	SW-4312		1	0,03
			K 25.1	30x155x305	SW-4316		1	0,07
			K 33.1					
			K 40.1	30x157x407	SW-6617		1	0,09
			K 50					
			K 65					
K 80								
10	Poklopac za čišćenje gornji unutrašnji / Cover for cleaning upper inner		K 18.1	3x105x205	SW-4313		1	0,53
			K 25.1	3x155x305	SW-4317		1	1,14
			K 33.1					
			K 40.1	4x157x407	SW-6618		1	2,04
			K 50					
			K 65					
K 80								
11	Vatrostalna opeka 100 / Refractory brick 100		K 18.1	80x100x110	K0000226		3	1,40
			K 25.1	80x120x110	K0000144		3	1,71
			K 33.1	80x120x110	K0000144		1	1,71
				80x100x110	K0000226		3	1,4
			K 40.1	80x120x110	K0000144		4	1,71
			K 50	80x120x110	K0000144		4	1,71
				80x100x110	K0000226		1	1,4
			K 65	80x120x110	K0000144		4	1,71
K 80	80x120x110	K0000144		2	1,4			
12	Livena gornja manja vrata / Cast iron upper smaller door		K 18.1	77x320x340	S0002980		1	12,20
			K 25.1	77x357x388	SW-4359		1	13,68
			K 33.1					
			K 40.1					
	Gornja vrata / Upper door		K 50	77x355x428	SW-6396		1	15,90
			K 65					
K 80								
13	Šipka-čaura osovine klapne / Bar sleeve for cover axle		K 18.1	20x50	SW-3694		1	0,09
			K 25.1					
			K 33.1					
			K 40.1					
			K 50					
			K 65					
K 80								

14	Dichtung za klapnu / <i>Gasket for cover</i>		K 18.1	30x20	SW-18534		3	0,05
			K 25.1					
			K 33.1					
			K 40.1					
			K 50					
15	Plastična ručica sa umetkom / <i>Plastic handle with insert</i>		K 18.1	90xØ30	K0000142		1	0,3
			K 25.1					
			K 33.1					
			K 40.1					
			K 50					
16	Kuglica F 35 sa unutrašnjim navojem M 10 / <i>Ball F 35 with inner thread M 10</i>		K 18.1	Ø35	K0001463		1	0,02
			K 25.1					
			K 33.1					
			K 40.1					
			K 50					
17	Šipka za češalj / <i>Bar for comb</i>		K 18.1	450xØ12	D0010348		1	0,38
			K 25.1	500xØ12	D0010193			
			K 33.1	560xØ12	D0010248			
			K 40.1	635xØ12	D0010383			
			K 50					
18	Češalj za čišćenje / <i>Cleaning comb</i>		K 18.1	315x80x30	D0010192		1	1,5
			K 25.1					
			K 33.1					
			K 40.1					
			K 50					

LIVENA DONJA VRATA ZA KOTLOVE / CAST LOWER DOOR FOR BOILERS: K 18.1; K 25.1; K 33.1; K 40.1









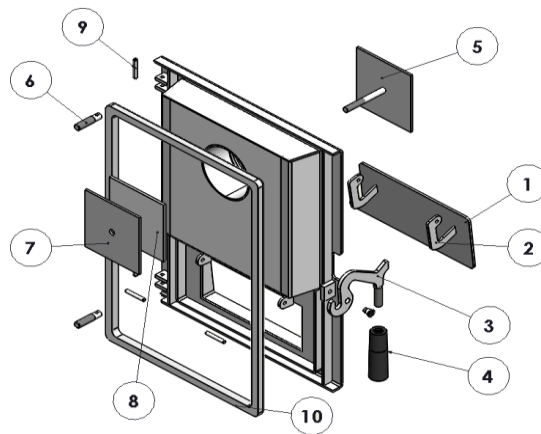



No.	Naziv / Name	Slika dela / pictures of parts	Tip kotla / Type of boiler	Dimenzija / Dimension	CODE PDM	CODE INFOerp	Q.	Težina / Weight (kg)
1	Livena vratanica promaje / <i>Cast iron small door for draft</i>		K 18.1	235x150x52	SW-4331		1	1,82
			K 25.1					
			K 33.1					
			K 40.1					
2	Plastična ručica sa umetkom / <i>Plastic handle with insert</i>		K 18.1	100xØ30	K0000155		1	0,2
			K 25.1					
			K 33.1					
			K 40.1					
3	Ručica vrata / <i>Door handle</i>		K 18.1	130x80x6	SW-4335		1	0,18
			K 25.1					
			K 33.1					
			K 40.1					

4	Čivija 6x36 / Bolt 6x36		K 18.1 K 25.1 K 33.1 K 40.1	6 x 36 DIN 1481	K0000024		5	0,005
5	Livena donja vrata bez otvora / Cast iron lower door without opening		K 18.1 K 25.1 K 33.1 K 40.1	460x332x70	K0001107		1	11,3
6	Brezon šarke vrata / Sleeve for door hinge		K 18.1 K 25.1 K 33.1 K 40.1	50xØ12	SW-3713		2	0,04
7	Šnjur donjih manjih livenih vrata / Packing for lower smaller cast iron door		K 18.1 K 25.1 K 33.1 K 40.1	14x14x1476	SW-4342		1	0,2
8	Izolacija vatrostalne ploče / Insulation for refractory plate		K 18.1 K 25.1 K 33.1 K 40.1	290x250x5	SW-4339		1	0,34
9	Vatrena ploča donjih livenih vrata / Fire plate for lower cast iron door		K 18.1 K 25.1 K 33.1 K 40.1	290x250x4	SW-4340		1	1,84
10	Flah vatrene ploče livenih donjih vrata / Flat bar for the fire plate for lower cast iron door		K 18.1 K 25.1 K 33.1 K 40.1	180x45x4	SW-4341		1	0,25

DONJA VRATA ZA KOTLOVE / LOWER DOOR FOR BOILERS: K50; K65 ;K80









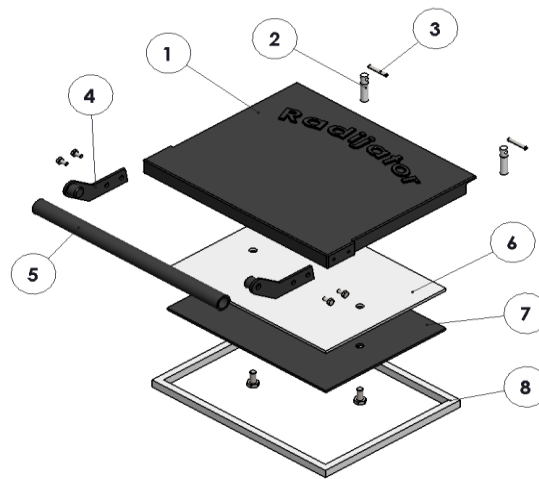

No.	Naziv / Name	Slika dela / pictures of parts	Tip kotla / Type of boiler	Dimenzija / Dimesion	CODE PDM	CODE INFOerp	Q.	Težina / Weight (kg)
1	Vratanca promaje / Small door for draught		K 50 K 65 K 80	274x113x4	SW-3975		1	0,87
2	Šarka vrata promaje / Hinge for door for draught		K 50 K 65 K 80	70x55x4	SW-3969		2	0,06
3	Sklop ručice donjih čeličnih vrata / Handle assembly for lower steel door		K 50 K 65 K 80	127x100x12	SW-3720		1	0,22
4	Plastična ručica sa umetkom / Plastic handle with insert		K 50 K 65 K 80	100xØ30	K0000155		1	0,20
5	Spoljašnji poklopac za otvor gorionika / Outside cover for burner opening		K 50 K 65 K 80	89x120x120	S0000417		1	0,50

6	Brezon šarke vrata / Sleeve for door hinge		K 50	50xØ12	SW-3713		2	0,04
			K 65					
			K 80					
7	Unutrašnji poklopac otvora za gorionik / Inside cover for burner opening		K 50	120x120x4	D0001987		1	0,45
			K 65					
			K 80					
8	Izolacija unutrašnjeg poklopca otvora za gorionik / Insulation for inside cover for burner opening		K 50	120x120x5	D0001986		1	0,07
			K 65					
			K 80					
9	Čivija 6 x 40 / Bolt 6 x 40		K 50	6x40 DIN 1481	K0000025		4	0,01
			K 65					
			K 80					
10	Pletenica donjih vrata / Packing for lower door		K 50	14x14x1668	SW-6407		1	0,26
			K 65					
			K 80					

LIVENA GORNJA MANJA VRATA ZA KOTLOVE / CAST UPPER SMALLER DOOR FOR BOILERS: K18.1; K25.1; K33.1; K40.1





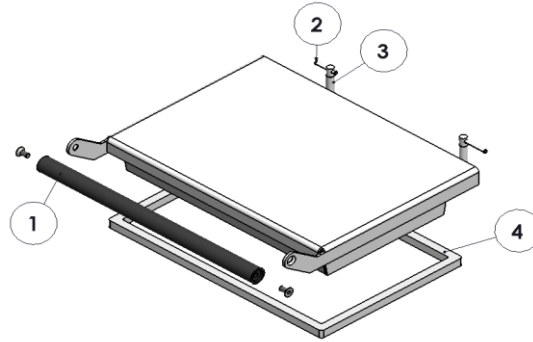

No.	Naziv / Name	Slika dela / pictures of parts	Tip kotla / Type of boiler	Dimenzija / Dimension	CODE PDM	CODE INFOerp	Q.	Težina / Weight (kg)
1	Livena gornja manja vrata / Cast iron upper smaller door		K 18.1	312x312x30	D0010592		1	8,00
			K 25.1	380x312x30	SW-4351		1	9,40
			K 33.1					
			K 40.1					
2	Brezon šarke vrata / Sleeve for door hinge		K 18.1	50xØ12	SW-3713		2	0,04
			K 25.1					
			K 33.1					
			K 40.1					
3	Čivija 6x36 / Bolt 6 x 36		K 18.1	6 x 36 DIN 1481	K0000024		2	0,01
			K 25.1					
			K 33.1					
			K 40.1					
4	Deo za vezivanje ručica vrata (levi + desni) / Part for tying of door handles (left + right)		K 18.1	130x50x20	S0000223/S0000224		1	0,14
			K 25.1					
			K 33.1					
			K 40.1					
5	Cev-ručica vrata / Pipe-Door handle		K 18.1	312xØ26,9	D0010597		1	0,58
			K 25.1	380xØ26,9	SW-4364		1	0,70
			K 33.1					
			K 40.1					
6	Keramički karton gornjih limenih manjih vrata / Ceramic cardboard for upper sheet steel smaller door		K 18.1	259x247x5	D0010594		1	0,30
			K 25.1	327x247x5	SW-4360		1	0,38
			K 33.1					
			K 40.1					
7	Beton / Concrete		K 18.1	237x200x36	D0011722		1	1,00

	Vatrostalna ploča gornjih limenih manjih vrata / Refractory plate for upper sheet steel smaller door		K 25.1 K 33.1 K 40.1	327x247x4	SW-4361		1	2,53
8	Pletenica gornjih manjih limenih vrata / Packing for upper sheet steel smaller door		K 18.1	14x14x1134	D0010596		1	0,15
			K 25.1	14x14x1270	SW-4362		1	0,18
			K 33.1					
			K 40.1					

GORNJA VRATA ZA KOTLOVE / UPPER DOOR FOR BOILERS: K50; K65 ;K80



No.	Naziv / Name	Slika dela / pictures of parts	Tip kotla / Type of boiler	Dimenzija / Dimension	CODE PDM	CODE INFOerp	Q.	Težina / Weight (kg)
1	Cev-ručica vrata / Pipe- Door handle		K 50	420xØ26,9	SW-6398		1	0,8
			K 65					
			K 80					
2	Brezon šarke vrata / Sleeve for door hinge		K 50	50xØ12	SW-3713		2	0,04
			K 65					
			K 80					
3	Čivija 6x40 / Bolt 6 x 40		K 50	6x40 DIN 1481	K0000025		2	0,01
			K 65					
			K 80					
4	Pletenica gornjih vrata / Packing for upper door		K 50	14x14x1396	SW-6395		1	0,22
			K 65					
			K 80					