

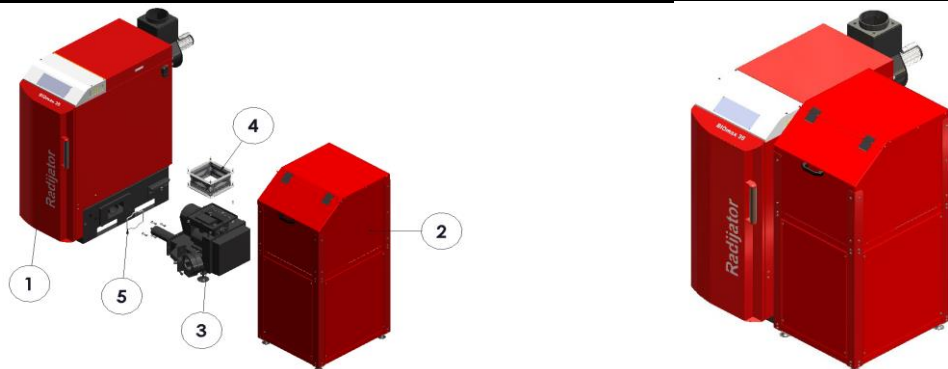

REZERVNI DELOVI BIOMAX 23 I 35







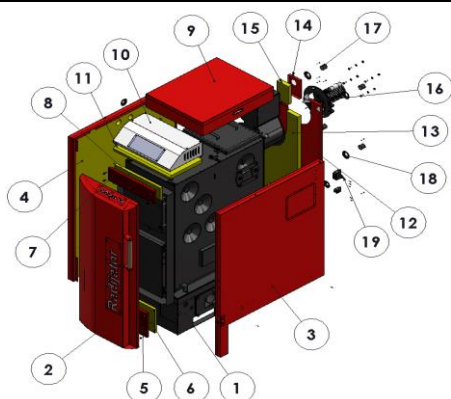

Spisak rezervnih delova za kotao **BIOMAX 23.2** & **BIOMAX 35.1** / List of spare parts for **BIOMAX 23.2** & **BIOMAX 35.1**

| No. | Slika dela / Pictures of parts | NAZIV / NAME | Tip kotla / Type of boiler | Dimenzija / Dimension (mm) | CODE PDM | CODE INFOerp | Q. | Težina / Weight (kg) |
|-----|--------------------------------|--|----------------------------|----------------------------|----------|--------------|----|----------------------|
| 0 | | ČIŠĆENJE KOTLA | BIOMAX 23.2 | 1180x560x1460 | S0002687 | | 1 | 370,00 |
| | | | BIOMAX 35.1 | 1480x630x1570 | S0002610 | | 1 | 461,60 |
| 1 | | Kotao sa oplatom / Boiler of out side jacket | BIOMAX 23.2 | 1180x560x1460 | S0002687 | | 1 | 370,00 |
| | | | BIOMAX 35.1 | 1480x630x1570 | S0002610 | | 1 | 461,60 |
| 2 | | Silos / Silo | BIOMAX 23.2 | 602x710x1565 | S0002599 | | 1 | 57,00 |
| | | | BIOMAX 35.1 | | | | | |
| 3 | | Dozer / Feeder | BIOMAX 23.2 | 537x566x733 | S0000708 | | 1 | 58,00 |
| | | | BIOMAX 35.1 | 560x732x540 | SW-13927 | | 1 | 58,00 |
| 4 | | Fleksibilna veza / Flexible connection | BIOMAX 23.2 | 243x243x132 | S0003827 | | 1 | 1,50 |
| | | | BIOMAX 35.1 | | | | | |
| 5 | | Pletenica / Ceramic rope | BIOMAX 23.2 | 6x6, L=433 | D0004582 | | 1 | 0,02 |
| | | | BIOMAX 35.1 | | | | | |

Kotao sa oplatom BIOMAX 23.2 & BIOMAX 35.1 / Boiler of out side jacket BIOMAX 23.2 & BIOMAX 35.1









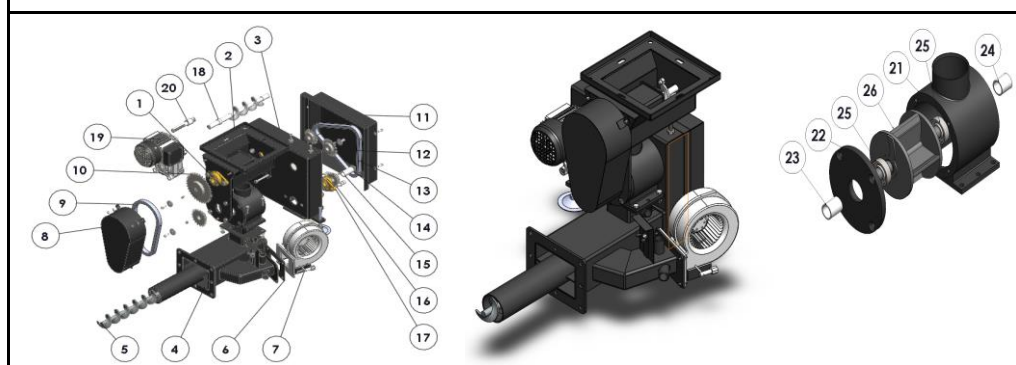

| No. | Slika dela / Pictures of parts | NAZIV / NAME | Tip kotla / Type of boiler | Dimenzija / Dimension (mm) | CODE PDM | CODE INFOerp | Q. | Težina / Weight (kg) |
|-----|--------------------------------|---|----------------------------|----------------------------|----------|--------------|----|----------------------|
| 1 | | Telo kotla sa ložištem / Body of boiler with socle of Combustion chamber | BIOMAX 23.2 | 1100x570x1460 | S0002688 | | 1 | 334,00 |
| | | | BIOMAX 35.1 | 1200x560x1570 | S0002587 | | 1 | 401,00 |
| 2 | | Sklop vrata / Door assembly | BIOMAX 23.2 | 85,4x450x1160 | S0002695 | | 1 | 12,87 |
| | | | BIOMAX 35.1 | 83x520x1280 | S0002612 | | 1 | 15,60 |
| 3 | | Sklop bočne desne strane oplata / Right side hand panel | BIOMAX 23.2 | 876x49x1149 | S0002766 | | 1 | 7,40 |
| | | | BIOMAX 35.1 | 950x69x1270 | S0002771 | | 1 | 9,20 |
| 4 | | Sklop bočne leve strane oplata / Left side hand panel | BIOMAX 23.2 | 876x49x1149 | S0002765 | | 1 | 7,40 |
| | | | BIOMAX 35.1 | 950x69x1270 | S0002772 | | 1 | 9,20 |
| 5 | | Međuvratnik oplata donji / Front middle panel part lower | BIOMAX 23.2 | 380x218x20 | D0009346 | | 1 | 0,70 |
| | | | BIOMAX 35.1 | 420x212x20 | D0009037 | | 1 | 0,75 |
| 6 | | Izolacija donjeg međuvratnika / Insolation of lower middle panel | BIOMAX 23.2 | 378x216x30 | D0017027 | | 1 | 0,12 |
| | | | BIOMAX 35.1 | 416x208x18,4 | D0017121 | | 1 | 0,08 |
| 7 | | Međuvratnik oplata gornji / Front middle panel part upper | BIOMAX 23.2 | 380x20x89,5 | D0009345 | | 1 | 0,35 |
| | | | BIOMAX 35.1 | 420x20x113 | D0009036 | | 1 | 0,45 |
| 8 | | Izolacija gornjeg međuvratnika / Insolation of upper middle panel | BIOMAX 23.2 | 378x88x30 | D0017028 | | 1 | 0,05 |
| | | | BIOMAX 35.1 | 416x109x18 | D0017122 | | 1 | 0,05 |
| 9 | | Sklop krova oplata / Top panel | BIOMAX 23.2 | 576x120x450 | S0002767 | | 1 | 3,80 |
| | | | BIOMAX 35.1 | 520x120x650 | S0002773 | | 1 | 4,60 |
| 10 | | Kućiče automatike / Control panel | BIOMAX 23.2 | 450x300x120 | S0002694 | | 1 | 2,80 |
| | | | BIOMAX 35.1 | 520x300x120 | S0002611 | | 1 | 3,12 |
| 11 | | Izolacija automatike / Insolation of control panel | BIOMAX 23.2 | 448x297x30 | D0017029 | | 1 | 0,20 |
| | | | BIOMAX 35.1 | 517x297x30 | D0017064 | | 1 | 0,23 |
| 12 | | Zadnja strana oplata / Back panel | BIOMAX 23.2 | 380x20x892 | D0009445 | | 1 | 2,10 |
| | | | BIOMAX 35.1 | 420x20x1009 | D0012362 | | 1 | 2,35 |
| 13 | | Izolacija zadnje strane oplata / Insolation of back panel | BIOMAX 23.2 | 890x378x30 | D0017030 | | 1 | 0,43 |
| | | | BIOMAX 35.1 | 416x30x1005 | D0012354 | | 1 | 0,50 |

| | | | | | | | | |
|----|---|--|-------------|-------------|----------|---|---|-------|
| 14 |  | Zadnja manja strana oplate / Smaller back panel | BIOMAX 23.2 | / | / | / | / | / |
| | | | BIOMAX 35.1 | 165x105x20 | D0012363 | | 1 | 0,15 |
| 15 |  | Izolacija zadnje manje strane oplate / Insolation of smaller back panel | BIOMAX 23.2 | / | / | / | / | / |
| | | | BIOMAX 35.1 | 103x161x130 | D0012356 | | 1 | 0,03 |
| 16 |  | Ventilator sa prirubnicom i štitnikom / Fan | BIOMAX 23.2 | 275x125 | S0003851 | | 1 | 11,50 |
| | | | BIOMAX 35.1 | | | | | |
| 17 |  | Plasticoni ukrasni spoljni cep 1"/ Decorative plastic outer cap 1/2" | BIOMAX 23.2 | Ø35,5x30 | K0000171 | | 1 | / |
| | | | BIOMAX 35.1 | | | | 4 | |
| 18 |  | Ukrasna guma 1"/ Decorative rubber 1" | BIOMAX 23.2 | / | K0000170 | | 6 | / |
| | | | BIOMAX 35.1 | | | | | |
| 19 |  | Plasticoni ukrasni unutrasnji cep 1/2"/ Plastic decorative inner cap 1/2" | BIOMAX 23.2 | / | K0000174 | | 3 | / |
| | | | BIOMAX 35.1 | | | | | |

Dozer BIOMAX 23.2 & Biomax 35.1





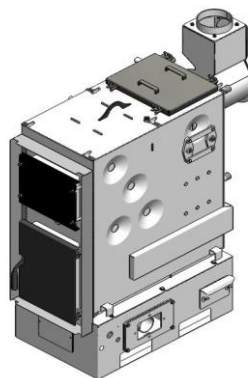
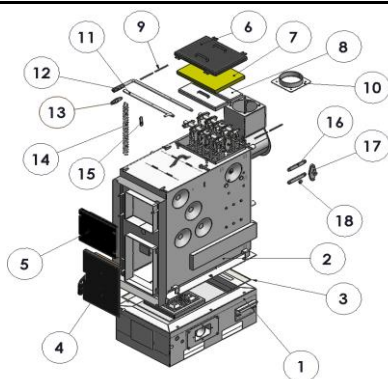

| No. | Slika dela / Pictures of parts | NAZIV / NAME | Tip kotla / Type of boiler | Dimenzija / Dimesion (mm) | CODE PDM | CODE INFOerp | Q. | Težina / Weight (kg) |
|-----|---|---|----------------------------|---------------------------|----------|--------------|----|----------------------|
| 1 |  | Valvola-čelijski transporter / Cell wheel | BIOMAX 23.2 | 210x172x155 | SW-3808 | 00011540 | 1 | 9,20 |
| | | | BIOMAX 35.1 | | | | | |
| 2 |  | Gornji sklop dozera / Feeder assembly- upper | BIOMAX 23.2 | 329x255x313 | SW-3820 | | 1 | 7,50 |
| | | | BIOMAX 35.1 | | | | | |
| 3 |  | Kutija lančanika / Chainwheel box | BIOMAX 23.2 | 430x416x316 | S0001557 | | 1 | 9,00 |
| | | | BIOMAX 35.1 | | | | | |
| 4 |  | Donji sklop dozera / Feeder assembly- lower | BIOMAX 23.2 | 505x335x185 | S0000709 | | 1 | 12,00 |
| | | | BIOMAX 35.1 | 545x337x208,5 | SW-3930 | | 1 | 10,60 |
| 5 |  | Donja spirala / Lowe feeder spiral | BIOMAX 23.2 | L=674 mm | SW-10190 | | 1 | 2,00 |
| | | | BIOMAX 35.1 | L=712,5mm | SW-14016 | 00014042 | 1 | 2,00 |
| 6 |  | Guma na prirubnici ventilatora / Rubber flange fan | BIOMAX 23.2 | 140x95 | K0000853 | | 1 | / |
| | | | BIOMAX 35.1 | | | | | |
| 7 |  | Ventilator na dozeru, WPA120 (R2E120-AR38-40) / FAN | BIOMAX 23.2 | 210x180x158 | K0001121 | 00008041 | 1 | 5,70 |
| | | | BIOMAX 35.1 | | | | | |
| 8 |  | Poklopac lančanika / Cover chainwheel | BIOMAX 23.2 | 305x170x91 | S0000682 | 00011592 | 1 | 0,70 |
| | | | BIOMAX 35.1 | | | | | |

| | | | | | | | | |
|----|---|---|-------------|-------------|----------|----------|---|------|
| 9 |  | Prenosnik snage LANAC-kraći / Power transmission chain - shorter | BIOMAX 23.2 | 083 650 | D0016699 | 00011506 | 1 | / |
| | | | BIOMAX 35.1 | | | | | |
| 10 |  | Lančanik,33Z 08B DIN 8192 / Chainwheel | BIOMAX 23.2 | 083 Z33 | K0000090 | 00011534 | 1 | / |
| | | | BIOMAX 35.1 | | | | | |
| 11 |  | Poklopac kutije lančanika / Cover chainwheel | BIOMAX 23.2 | 356x323x95 | SW-4954 | 00011583 | 1 | 2,04 |
| | | | BIOMAX 35.1 | | | | | |
| 12 |  | Lančanik,18Z 08B DIN 8192 / Chainwheel | BIOMAX 23.2 | 083 Z18 | K0000089 | 00011508 | 2 | / |
| | | | BIOMAX 35.1 | | | | | |
| 13 |  | Prenosnik snage LANAC-duži / Power transmission chain - longer | BIOMAX 23.2 | 083 662 | D0016700 | 00011506 | 1 | / |
| | | | BIOMAX 35.1 | | | | | |
| 14 |  | Pritezna pločica lančanika / Chainwheel plate for straining | BIOMAX 23.2 | Ø28x3 | SW-3833 | | 6 | 0,02 |
| | | | BIOMAX 35.1 | | | | | |
| 15 |  | Čaura veće osovine drugog ležaja / Spacer sleeve of bigger axle bearing | BIOMAX 23.2 | 25x50 | SW-4512 | | 1 | / |
| | | | BIOMAX 35.1 | | | | | |
| 16 |  | Lančanik,15Z 08B DIN 8192 / Chainwheel | BIOMAX 23.2 | 083 Z15 | K0000087 | 00011507 | 2 | / |
| | | | BIOMAX 35.1 | | | | | |
| 17 |  | Ležaj-UCFL 204 - dm20 / Bearing UCFL 204 | BIOMAX 23.2 | UCFL 204 | K0000096 | 00012290 | 4 | / |
| | | | BIOMAX 35.1 | | | | | |
| 18 |  | Spirala gornja / Upper feeder spiral | BIOMAX 23.2 | L=327,5mm | SW-3822 | | 1 | 0,90 |
| | | | BIOMAX 35.1 | | | | | |
| 19 |  | Motor - reduktor ABM 0.090kw / Gear motor | BIOMAX 23.2 | 145x210x182 | K0000401 | | 1 | 9,60 |
| | | | BIOMAX 35.1 | | | | | |
| 20 |  | Osovina motora / Axle for motor | BIOMAX 23.2 | L=118mm | D0005009 | | 1 | 0,30 |
| | | | BIOMAX 35.1 | | | | | |
| 21 |  | Kućiče valvole-čelijski transporter / Housing Cell wheel | BIOMAX 23.2 | 155x100x172 | SW-3802 | | 1 | 5,70 |
| | | | BIOMAX 35.1 | | | | | |
| 22 |  | Poklopac valvole / Cover cell wheel | BIOMAX 23.2 | Ø140x10 | SW-3804 | | 1 | 1,20 |
| | | | BIOMAX 35.1 | | | | | |
| 23 |  | Čaura rotora veća / Bigger spacer sleeve | BIOMAX 23.2 | Ø25x30 | SW-3806 | | 1 | / |
| | | | BIOMAX 35.1 | | | | | |
| 24 |  | Čaura rotora manja / Smaller spacer sleeve | BIOMAX 23.2 | Ø25x25 | SW-3807 | | 1 | / |
| | | | BIOMAX 35.1 | | | | | |
| 25 |  | Ležaj 6004 2RS / Bearing 6004 2RS | BIOMAX 23.2 | 6004 2RS | K0000104 | 00008401 | 2 | / |
| | | | BIOMAX 35.1 | | | | | |
| 26 |  | Rotor valvole / Cell wheel rotor | BIOMAX 23.2 | 210xØ110 | SW-3803 | | 1 | 2,20 |
| | | | BIOMAX 35.1 | | | | | |
| 27 |  | Stopica dozera / Legs of feeder | BIOMAX 23.2 | M12 x 120 | K0000139 | 00014044 | 2 | 0,30 |
| | | | BIOMAX 35.1 | | | | | |

Sklop kotla i ložišta / Assembly of Exchanger and Combustion chamber BIOMAX 23.2 & Biomax 35.1









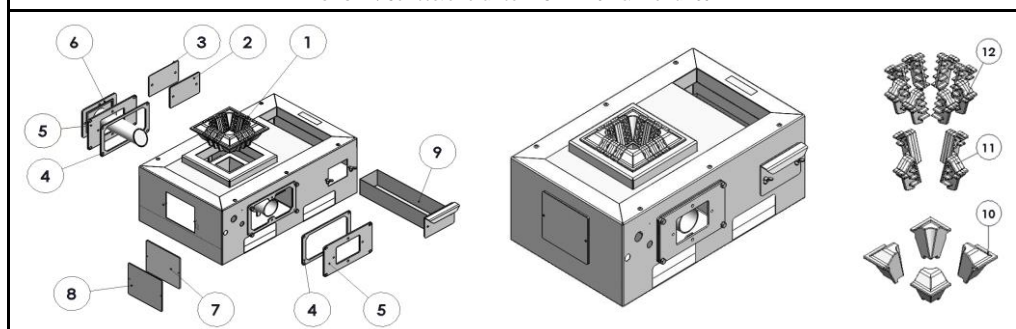





| No. | Slika dela / Pictures of parts | NAZIV / NAME | Tip kotla / Type of boiler | Dimenzija / Dimension (mm) | CODE PDM | CODE INFOerp | Q. | Težina / Weight (kg) |
|-----|--------------------------------|---|----------------------------|----------------------------|----------|--------------|----|----------------------|
| 1 | | Ložište / Combustion chamber | BIOMAX 23.2 | 798x515x391 | SW-4950 | | 1 | 62,00 |
| | | | BIOMAX 35.1 | 845x585x391 | SW-4910 | | 1 | 74,00 |
| 2 | | Sklop izmenjivača / Exchanger | BIOMAX 23.2 | 843x860x901 | S0002689 | | 1 | 183,80 |
| | | | BIOMAX 35.1 | 937x520x1047 | S0002588 | | 1 | 245,00 |
| 3 | | Pletenica ložišta / Ceramic rope of Combustion chamber | BIOMAX 23.2 | 6x6x2280 | SW-5441 | | 1 | 0,04 |
| | | | BIOMAX 35.1 | 6x6x2530 | SW-5275 | | 1 | 0,05 |
| 4 | | Donja vrata / Lower door | BIOMAX 23.2 | 350x462x115 | S0003210 | 00000060 | 1 | 23,00 |
| | | | BIOMAX 35.1 | | | | | |
| 5 | | Čeoni poklopac izmenjivača / Upper door | BIOMAX 23.2 | 354x74x290 | S0003315 | | 1 | 14,80 |
| | | | BIOMAX 35.1 | | | | | |
| 6 | | Spoljašnji poklopac proreza za čišćenje / Outside cover of cleaning | BIOMAX 23.2 | 352x351x65 | SW-5136 | | 1 | 6,80 |
| | | | BIOMAX 35.1 | 387x400x65 | SW-4994 | | 1 | 8,50 |
| 7 | | Izolacija gornjeg otvora za čišćenje / Insolation of upper cover of cleaning | BIOMAX 23.2 | 324x251x30 | SW-5163 | | 1 | 0,13 |
| | | | BIOMAX 35.1 | 374x285x30 | SW-5008 | | 1 | 0,16 |
| 8 | | Cance gornjeg otvora / Upper cover | BIOMAX 23.2 | 312x113x45 | SW-6155 | | 2 | 1,80 |
| | | | BIOMAX 35.1 | 360x125x45 | SW-6164 | | 2 | 2,20 |
| 9 | | Pletenica gornjeg betona za čišćenje / Ceramic rope upper concrete for cleaning | BIOMAX 23.2 | 6x6x308 | SW-5175 | | 4 | / |
| | | | BIOMAX 35.1 | 6x6x125.5 | SW-5015 | | 4 | / |
| 10 | | Gornji poklopac kutije sekundarnog vazduha / Top box cover secondary air | BIOMAX 23.2 | 200x200x44 | S0001569 | | 1 | 1,40 |
| | | | BIOMAX 35.1 | 200x200x44 | SW-7263 | | 1 | 1,30 |
| 11 | | Osovina mehanizma za čišćenje / Mechanism for cleaning | BIOMAX 23.2 | Ø20x427 | D0009697 | | 1 | 1,03 |
| | | | BIOMAX 35.1 | Ø20x480 | D0009556 | | 1 | 1,16 |
| 12 | | Ručica mehanizma za čišćenje / Handle mechanism for cleaning | BIOMAX 23.2 | 500x253x20 | S0002841 | | 1 | 1,85 |
| | | | BIOMAX 35.1 | 555x20x253 | S0002817 | | 1 | 1,97 |
| 13 | | Usica mehanizma za ciscenje | BIOMAX 23.2 | 98.2x38.8x6 | D0009698 | | 20 | 0,10 |
| | | | BIOMAX 35.1 | 109x39x6 | D0009491 | | 20 | 0,12 |

| | | | | | | | | |
|----|---|---|-------------|-----------|----------|--|----|------|
| 14 |  | Turbulator/ Turbulator | BIOMAX 23.2 | 24x307 | D0009734 | | 20 | 0,25 |
| | | | BIOMAX 35.1 | 29x450 | D0009733 | | 20 | 0,41 |
| 15 |  | Ušica | BIOMAX 23.2 | 90x20x5 | D0009510 | | 20 | 0,07 |
| | | | BIOMAX 35.1 | | | | | |
| 16 |  | Flah mehanizma | BIOMAX 23.2 | 6x153x30 | D0009699 | | 2 | 0,19 |
| | | | BIOMAX 35.1 | 5x174x30 | D0009554 | | 2 | 0,22 |
| 17 |  | Sklop prenosioca / Gear assembly | BIOMAX 23.2 | 145x60x25 | S0002832 | | 2 | 0,53 |
| | | | BIOMAX 35.1 | | | | | |
| 18 |  | Podloška mehanizma za čišćenje / Washer mechanism for cleaning | BIOMAX 23.2 | Ø30x6 | D0009621 | | 2 | / |
| | | | BIOMAX 35.1 | | | | | |

LOŽIŠTE / Combustion chamber BIOMAX 23.2 & Biomax 35.1



| No. | Slika dela / Pictures of parts | NAZIV / NAME | Tip kotla / Type of boiler | Dimenzija / Dimension (mm) | CODE PDM | CODE INFOerp | Q. | Težina / Weight (kg) |
|-----|---|--|----------------------------|----------------------------|----------|--------------|----|----------------------|
| 1 |  | Sklop livenih segmenata / Cast segments | BIOMAX 23.2 | 248x248x100 | S0000791 | | 1 | 9,70 |
| | | | BIOMAX 35.1 | 248x248 | SW-7475 | / | 1 | 13,50 |
| 2 |  | Izolacioni karton bočnog proreza pepeljare / Insulation of flange of ashtray | BIOMAX 23.2 | 120x185 | SW-1827 | | 1 | 0,10 |
| | | | BIOMAX 35.1 | | | | | |
| 3 |  | Poklopac bočnog proreza pepeljare / Cover side of ashtray | BIOMAX 23.2 | 120x185 | SW-1828 | | 1 | 0,60 |
| | | | BIOMAX 35.1 | | | | | |
| 4 |  | Izolacioni karton bočne prirubnice / Insolation of flange of combustion chamber | BIOMAX 23.2 | 300x173 | SW-4971 | | 2 | 0,30 |
| | | | BIOMAX 35.1 | | | | | |
| 5 |  | Prirubnica ložišta / Flange of combustion chamber | BIOMAX 23.2 | 300x173 | SW-4970 | | 2 | 2,50 |
| | | | BIOMAX 35.1 | | | | | |
| 6 |  | Bočni poklopac ložišta / Combustion chamber cover | BIOMAX 23.2 | 210x160x220 | SW-5033 | | 1 | 3,30 |
| | | | BIOMAX 35.1 | 210x160x265 | SW-5012 | 00011602 | 1 | 3,50 |
| 7 |  | Izolacioni karton prednjeg ložišta / Insolation for front cover of comb.chamber | BIOMAX 23.2 | 210x180 | SW-1755 | | 1 | 0,20 |
| | | | BIOMAX 35.1 | | | | | |
| 8 |  | Poklopac prednje strane ložišta / Cover for front side of comb. Chamber | BIOMAX 23.2 | 210x180 | SW-1753 | 00014040 | 1 | 1,00 |
| | | | BIOMAX 35.1 | | | | | |
| 9 |  | Pepeljara / Ashtray | BIOMAX 23.2 | 185x120x480 | SW-3011 | 00011612 | 1 | 1,70 |
| | | | BIOMAX 35.1 | | | | | |

| | | | | | | | | |
|----|---|--|-------------|-----------|----------|--|----|------|
| 10 |  | Ugaoni liveni segment / Casting segment - corner | BIOMAX 23.2 | 76x76x95 | D0002841 | | 4 | 0,85 |
| | | | BIOMAX 35.1 | 76x76x95 | K0000289 | | | 1,90 |
| 11 |  | Zatvoreni segment / Casting segment - closed | BIOMAX 23.2 | 76x32x105 | D0002840 | | 12 | 0,50 |
| | | | BIOMAX 35.1 | 76x105x32 | K0000290 | | | 4 |
| 12 |  | Otvoreni segment / Casting segment - open | BIOMAX 23.2 | / | / | | / | / |
| | | | BIOMAX 35.1 | 76x105x32 | K0000291 | | | 8 |

Donja vrata / BIOMAX 23.2 & Biomax 35.1

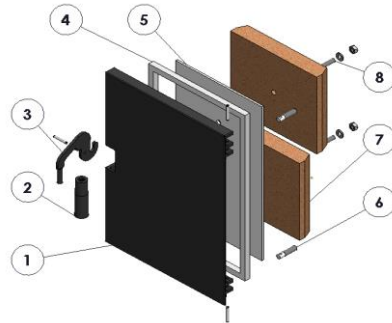

| No. | Slika dela / Pictures of parts | NAZIV / NAME | Tip kotla / Type of boiler | Dimenzija / Dimension (mm) | CODE PDM | CODE INFOerp | Q. | Težina / Weight (kg) |
|-----|---|--|----------------------------|----------------------------|----------|--------------|----|----------------------|
| 1 |  | Livena donja vrata / Cast lower door | BIOMAX 23.2 | 350x462 | D0011803 | | 1 | 11,50 |
| | | | BIOMAX 35.1 | | | | | |
| 2 |  | Plastična ručica / Plastic of handle for door | BIOMAX 23.2 | 30x100 (M12) | K0000155 | 00000175 | 2 | 0,20 |
| | | | BIOMAX 35.1 | | | | | |
| 3 |  | Sklop ručice / Handle for the door | BIOMAX 23.2 | 111x102 (M12) | S0003659 | | 2 | 0,30 |
| | | | BIOMAX 35.1 | | | | | |
| 4 |  | Pletenica donjih vrata / Ceramic rope | BIOMAX 23.2 | 14x14x1480 | D0011804 | 00000029 | 1 | 0,30 |
| | | | BIOMAX 35.1 | | | | | |
| 5 |  | Izolacioni karton / Insulating cardboard | BIOMAX 23.2 | 252x419 | D0008638 | | 1 | 0,50 |
| | | | BIOMAX 35.1 | | | | | |
| 6 |  | Brezon šarke vrata / Bolt the hinge | BIOMAX 23.2 | M12x50 | SW-3713 | | 4 | 0,10 |
| | | | BIOMAX 35.1 | | | | | |
| 7 |  | Vatrostalna opeka donjih vrata / Bricks for the lower door | BIOMAX 23.2 | 209x252x40 | K0000254 | 00011866 | 2 | 5,00 |
| | | | BIOMAX 35.1 | | | | | |
| 8 |  | Navojna šipka M10 | BIOMAX 23.2 | M10x65 | D0011805 | | 2 | 0,10 |
| | | | BIOMAX 35.1 | | | | | |

Gornji poklopac za čišćenje / BIOMAX 23.2 & Biomax 35.1

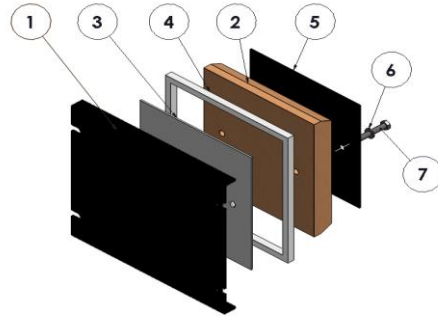

| No. | Slika dela / Pictures of parts | NAZIV / NAME | Tip kotla / Type of boiler | Dimenzija / Dimension (mm) | CODE PDM | CODE INFOerp | Q. | Težina / Weight (kg) |
|-----|--------------------------------|---|----------------------------|----------------------------|----------|--------------|----|----------------------|
| 1 | | Gornja vrata / Upper door | BIOMAX 23.2 | 354x27x290 | D0010411 | | 1 | 7,30 |
| | | | BIOMAX 35.1 | | | | | |
| 2 | | Vatrootalna opeka gornjih vrata-manja / Bricks for the upper door | BIOMAX 23.2 | 254x250x40 | K0001010 | | 1 | 5,90 |
| | | | BIOMAX 35.1 | | | | | |
| 3 | | Izolacija vrata / Insulation doors | BIOMAX 23.2 | 250x256x3 | D0010413 | | 1 | 0,20 |
| | | | BIOMAX 35.1 | | | | | |
| 4 | | Pletenica gornjih vrata /Ceramic rope | BIOMAX 23.2 | 12x14x1255 | D0010414 | | 1 | 0,15 |
| | | | BIOMAX 35.1 | | | | | |
| 5 | | Ploca izolacije vrata / Panel insulation doors | BIOMAX 23.2 | 252x228x3 | D0012303 | | 1 | 1,35 |
| | | | BIOMAX 35.1 | | | | | |
| 6 | | Vijak sa šestougaonom glavom M10 x60 DIN 933 / Screw M10 x 60 DIN 933 | BIOMAX 23.2 | M10x60 | K0000017 | | 2 | / |
| | | | BIOMAX 35.1 | | | | | |
| 7 | | Podloška 10.5x2 A DIN 125 / Washer 10.5x2 A DIN 125 | BIOMAX 23.2 | 10.5x2 | K0000030 | | 2 | / |
| | | | BIOMAX 35.1 | | | | | |

ELEKTRO KOMPONENTE I OSTALO / Electrical component & other BIOMAX 23.2 & Biomax 35.1

| No. | Slika dela / Pictures of parts | NAZIV / NAME | Tip kotla / Type of boiler | Dimenzija / Dimension (mm) | CODE PDM | CODE INFOerp | Q. | Težina / Weight (kg) |
|-----|--------------------------------|--|----------------------------|----------------------------|--------------|--------------|----|----------------------|
| 0 | | Automatika TIEMME SY325_Pellet_Basic | BIOMAX 23.2 | | K0001165 | | 1 | / |
| | | | BIOMAX 35.1 | | | | | |
| 1 | | Osigurač za automatiku / Fuse for control | BIOMAX 23.2 | | nema za sada | 00011017 | | / |
| | | | BIOMAX 35.1 | | | | | |
| 2 | | 7-polni konektor muški / 7-pole connector attach | BIOMAX 23.2 | / | K0000277 | 00008279 | 3 | / |
| | | | BIOMAX 35.1 | | | | 3 | |
| 3 | | 7-polni konektor ženski / 7-pole connector | BIOMAX 23.2 | / | K0000540 | 00008268 | 2 | / |
| | | | BIOMAX 35.1 | | | | 2 | |
| 4 | | 3-polni konektor muški / 3-pole connector attach | BIOMAX 23.2 | / | K0000278 | 00009448 | 1 | / |
| | | | BIOMAX 35.1 | | | | 1 | |

| | | | | | | | | |
|----|---|--|-------------|------------|----------|----------|---|-------|
| 5 |  | 3-polni konektor ženski / 3-pole connector | BIOMAX 23.2 | / | K0001099 | 00009449 | 2 | / |
| | | | BIOMAX 35.1 | | | | 2 | |
| 6 |  | Samo Ventilator / Fan | BIOMAX 23.2 | 275x125 | K0000531 | / | 1 | 11,50 |
| | | | BIOMAX 35.1 | | | | | |
| 7 |  | Flex.rebrasto crevo Ø8 / Flexible ribbed pipe Ø8 | BIOMAX 23.2 | 6,2m | K0001084 | | 1 | / |
| | | | BIOMAX 35.1 | 4,2m | | | 1 | |
| 8 |  | Flex.rebrasto crevo Ø10 / Flexible ribbed pipe Ø10 | BIOMAX 23.2 | 2m | K0001186 | | 1 | / |
| | | | BIOMAX 35.1 | 2,5m | | | 1 | |
| 9 |  | Flex.rebrasto crevo Ø12 / Flexible ribbed pipe Ø12 | BIOMAX 23.2 | 1m | K0001086 | | 1 | / |
| | | | BIOMAX 35.1 | 1,2m | | | 1 | |
| 10 |  | Flex.rebrasto crevo Ø28 / Flexible ribbed pipe Ø28 | BIOMAX 23.2 | 0,65m | K0001187 | | 1 | / |
| | | | BIOMAX 35.1 | 0,65m | | | 1 | |
| 11 |  | Nivelaciona nogica- metalna F 60 / Leveling legs | BIOMAX 23.2 | / | K0001585 | | 4 | 0,30 |
| | | | BIOMAX 35.1 | | | | | |
| 12 |  | Keramički grejač raušet 170 W / Ignitioner 170 W | BIOMAX 23.2 | / | K0001194 | 12253 | 1 | / |
| | | | BIOMAX 35.1 | | | | | |
| 13 |  | Sigurnosni termostat 110-6°, C 250V ~, STB 115408 / Safety thermostat 110-6°, C 250V ~, STB 115408 | BIOMAX 23.2 | | K0001345 | | 1 | |
| | | | BIOMAX 35.1 | | | | | |
| 13 |  | Sonda za temp. vode u kotlu, NTC 10k,6x30mm / Water probe | BIOMAX 23.2 | L =2000 mm | K0001478 | / | 1 | / |
| | | | BIOMAX 35.1 | | | | | |
| 14 |  | Sonda dimovodnih gasova / Flue gas probe | BIOMAX 23.2 | L =2500 mm | K0001362 | / | 1 | / |
| | | | BIOMAX 35.1 | | | | | |